

# *Dynatuner*

**STEREOMATIC  
MULTIPLEX  
MODEL FM-3**

SERIAL NUMBER

16516156

This number must be mentioned in all communications concerning Dynakit.

**INSTRUCTIONS FOR**

**ASSEMBLY  
ALIGNMENT  
OPERATION**



Price **\$1.00**

126416

**DYNA COMPANY**

**DYNACO**

3916 POWELTON AVE.  
PHILADELPHIA 4, PA.

## CONTENTS

Operating Instructions .....	3
Technical Description .....	4
General Wiring Practice .....	6
Assembly Instructions .....	7
Alignment Instructions .....	16
240 Volt Power Transformer .....	19
In Case of Difficulty .....	20
Service and Warranty .....	21
How to Make a Folded Dipole Antenna .....	22
Parts List .....	22
Voltage Check Points .....	23

## SPECIFICATIONS

### BASED ON IHF STANDARD T-100

<b>Useable Sensitivity:</b>	4 microvolts for total noise and distortion 30 db below 100% modulation
<b>Signal-to-Noise Ratio:</b>	70 db @ 100% modulation
<b>Harmonic Distortion:</b>	less than 0.25% @ 100% modulation
<b>Drift:</b>	less than 0.03%
<b>Frequency Response:</b>	± 0.5 db 10 cps to 15 KC
<b>Capture Ratio:</b>	5 db
<b>Selectivity:</b>	54 db
<b>Audio Hum:</b>	73 db below 1 volt output
<b>AM Suppression:</b>	greater than 63 db

### ADDITIONAL SPECIFICATIONS

<b>IM Distortion:</b>	less than 0.5% from 10 microvolts to 100,000 microvolts @ 100% modulation
<b>Audio Output:</b>	2 volts @ 100% modulation
<b>Output Impedance:</b>	less than 5000 ohms
<b>Discriminator Peak to Peak Separation:</b>	greater than 900 KC
<b>Antenna Input:</b>	300 Ω balanced 75 Ω unbalanced
<b>Dial Calibration Accuracy:</b>	0.2%
<b>Power Consumption:</b>	55 watts

### STEREOPHONIC PERFORMANCE

<b>Useable Sensitivity:</b>	3 db less than mono mode
<b>IM or Harmonic Distortion:</b>	less than 1% (including 19 KC and 38 KC residual)
<b>Separation:</b>	30 db

## THE FM-3 DYNATUNER

Your FM-3 Dynatuner is one of the most thoroughly researched and field tested components in the high fidelity industry. More than four years of engineering effort have been devoted to this one design with two specific goals in mind: one, performance which cannot be improved at the present state of the art; two, assurance that this performance level can be achieved and maintained by the user in the home.

Side-by-side listening comparisons of the Dynatuner with tuners several times its cost demonstrate the great extent to which these goals have been achieved. Published specifications cannot define the clear superiority of the Dynatuner in low distortion reception of both very weak and exceedingly powerful signals, its remarkable freedom from the problems of cross-modulation and severe multipath effects, its high order of suppression of impulse-type interference, its exceptional capacity to handle severely overmodulated signals without distortion, and its unique ability to maintain full stereo separation with the weakest signals.

These comparisons can be demonstrated using Dynatuners built and aligned by novice constructors, and it is this that represents a fundamental difference from other designs. The Dynatuner is a fresh engineering concept, not an adaptation of an existing production unit. Every portion of the circuit has been carefully investigated in terms both of performance maxima and of the overall stability of operation and simplicity of adjustment required of a kit design. The net result significantly surpasses on all counts units which require that certain sections be pre-built and aligned, and which are therefore incapable of complete home alignment.

The Dynatuner provides the same top performance in your home as in the laboratory, as it can always be properly aligned using the unique procedure detailed later in this manual. This ability to be aligned without test equipment, with an alignment as accurate as can be performed in the laboratory, means that after shipping, after aging, after tube replacement, or after any other cause for change in alignment, the unit can be restored to peak performance.

In addition to the adjustment requirements, the basic engineering objective was to produce a tuner with sufficient sensitivity for fringe area reception, with distortion levels of the recovered audio signal comparable to that measured on the best of audio amplifiers. The concentration of effort to reduce distortion of all types has produced a tuner which is unquestionably one of the very lowest distortion tuners available at any price.

The significant advantages of etched circuit construction in terms of reliability, reproducibility and durability are amply demonstrated in the Dynatuner. Their use has further accomplished the ultimate goal of improved performance. In no other tuner—kit or factory wired—has exact component placement and lead layout been so accurately defined. The excellent specifications of the Dynatuners are possible, and guaranteeable, unit to unit, lab model to production kit, because of the extraordinary uniformity which etched circuits provide, and the inherent stability of the circuit configuration.

There has been no intent to enter the sensitivity specification race (claims often engineered by the advertising department). However, using the sensitivity standards proposed by the Institute of High Fidelity, this tuner belongs

in the highly sensitive class and, in fact, will provide listenable reception of more stations than tuners of ostensibly higher sensitivity rating.

There are many parameters in addition to sensitivity and distortion which are part of a completely satisfactory tuner design. Some are measurable; some are intangible. The design requirements for a premium quality kit lead automatically to a distinctly superior factory assembled tuner as well. Extensive field testing under adverse and marginal conditions has proven the Dynatuner to be as fine a tuner as can be obtained today regardless of price or specification claims.

### Operation of the Controls

Operation of your FM-3 is remarkably simple. Its highly refined engineering combines the performance of far more costly and complex FM tuners with the operating ease which has become a Dyna hallmark. The elimination of front panel adjustments and controls is possible only through exhaustive engineering research to accomplish their objectives by automation, freeing the listener to enjoy exceptional FM reception.

The function of the power switch is obvious. This switch also controls the AC outlet on the rear of the tuner so that it is possible, if desired, to turn both tuner and amplifier, for example, on and off simultaneously if no preamplifier is used. It is also possible when using the Dynatuner with equipment which has additional switching facility, such as the Dyna PAS preamplifiers or SCA-35 amplifier, to leave the Dynatuner power switch "ON", and use the amplifier for all switching.

The tuning knob is used to select stations. When the station is correctly tuned, the *lower tuning eye will close to its maximum. Always tune a station while watching the tuning eye*, rather than trying to set to a precise frequency on the tuning dial. The eye is designed so that it will never overlap, but at any signal strength, *there will be a single point of correct tuning*. At this point you will receive the station with lowest distortion, maximum noise rejection and maximum separation of a stereo signal.

The tuning eye will indicate maximum closure with a signal strength below 20  $\mu\text{v}$ , yet higher signal strengths will not overlap it. The precise center of channel is always apparent—there is no "flat spot". It will indicate signals as weak as 1  $\mu\text{v}$ , but these signals are likely to fluctuate widely. Normal center channel indication may be anywhere between  $\frac{1}{4}$  division and 3 divisions gap on the reference grid, depending on the particular tuner, and signal strength.

Once a station is tuned, the upper beam, or STEREOCATOR, will indicate immediately whether or not the broadcast is in stereo. Between stations the STEREOCATOR may light or flicker. There can be no confusion as to whether or not you are listening to a stereo broadcast if you *tune for closure of the lower tuning eye first*, and then observe whether or not STEREO is lighted above it.

The STEREOCATOR operates from the 19KC pilot signal which is an integral part of all stereo broadcasts. Occasionally there may be instances where a station neglects to turn off this 19KC pilot when it reverts to monophonic programming, and this will give you an erroneous STEREO indication. Noise on extremely weak signals (there is some 19KC in random noise) and also 19KC harmonics in the program material may cause some flickering of the

STEREOCATOR during mono reception, but this is of no consequence.

The volume control knob actuates a push-pull Stereomatic/Mono switch. When the knob is pushed "IN", the Dynatuner will switch to full separation stereo operation when tuned to a stereo signal, and will automatically revert to mono operation (through both channels) on mono broadcasts. The normal position of this control is "IN".

It may occasionally be desirable to disable the Stereomatic feature, and for this, the tuner can be locked in mono operation by pulling the volume control "OUT". This will enable you to make monophonic recordings of stereo programs, or to eliminate spurious interference on a mono broadcast. Sometimes a very weak station can be received with less background interference by operating the tuner in the mono mode. The tuner will still indicate STEREO when you are tuned to a stereo broadcast, but in other respects reception will be identical to a purely monophonic tuner. This switch does not change the tuner in any obvious way—the sound level, frequency response, and distortion are the same.

The volume control is used primarily to set the level of the Dynatuner to match that of other program sources, so that when you switch your control amplifier's inputs, they are heard at comparable levels. Normally in this usage, the Dynatuner's volume control will be operated at  $\frac{3}{4}$  clockwise rotation or higher. If the tuner is used with a basic power amplifier only, such as the Dyna Stereo 70 or Stereo 35, then this operates as a conventional volume control for the system.

### Installation

There are two audio output sockets on the Dynatuner. The socket marked "A" on the bottom plate (the one nearest the line cord) is the left channel output. The "B" (outer) socket is the right channel output. The two shielded cables supplied (or similar type up to 25 feet in length) should be connected between these sockets and the "Radio" input (sometimes marked FM-MPX, or FM-AM) of the control amplifier or preamplifier. The Dynatuner can be connected to any audio input of 100,000 ohms or higher input impedance which can accept signal levels between one and two volts.

The Dynatuner can also be connected directly to any basic power amplifier which has an input sensitivity of less than 2 volts for full output. The amplifier may be connected to the switched AC outlet on the Dynatuner, and the volume level would be adjusted with the tuner's volume control.

The Dynatuner's line cord should be plugged into an AC receptacle furnishing 120 volts of 60 cycle current (120 or 240 volts at 50 or 60 cycles with the PB-012 optional power transformer).

### Antennas

Every FM tuner requires an antenna. For some metropolitan area use, a twin lead folded dipole is adequate for local station reception. Instructions for making one from the flat wire included with the kit are given in a later section of this manual. The television type known as "rabbit ears" is also suitable if fully extended. Either of these antennae should be rotated for best reception, and their most favorable orientation may vary with different stations.

The normal antenna lead-in wire is 300 ohm twin lead, similar to that supplied with the kit. The two leads should be connected to the two outermost antenna screw terminals,

leaving the center terminal unconnected. In difficult reception areas, it is sometimes necessary to use coaxial cable for the antenna lead-in. The Dynatuner has provision for using 75 ohm coaxial cable by connecting the shield of the cable to the center antenna screw terminal, and the center conductor of the cable to either of the outer screw terminals (but not both).

An outdoor FM antenna is always better than an indoor one, particularly if reception is desired over long distances. Stereo reception is also more critical of antennae than comparable mono results. High gain antenna arrays are available for fringe area reception. These are preferable to the "omni-directional" or "non-directional" type, but should preferably be used with a rotator. Your dealer can advise you on the use of these antennae, or you can write to antenna manufacturers for detailed information.

You should realize that when difficult reception conditions are encountered, improving the antenna will have far more effective results than any other remedy, including attempts to improve a tuner's sensitivity. The extreme sensitivity of the Dynatuner, coupled with its exceptional limiting action on very weak signals, may well enable you to listen to stations you have not received before, when this tuner is coupled with a properly designed antenna.

### Mounting the Dynatuner

The Dynatuner, like all electronic devices, generates some heat. Because the tuner has been designed with the cover as an integral part, the unit in effect creates its own thermal environment, and adequate allowance has been made in the design for this normal temperature rise. Its heat is equivalent to a 60 watt light bulb and, therefore, adequate ventilation is required. There should be a minimum of three inches of air above and behind the Dynatuner. Never put anything on top of the case while the tuner is operating. When stacked with the Dyna PAS preamplifier, the tuner must be installed above the preamplifier. The preamplifier does not require ventilation. The tuner cannot be stacked above the Dyna SCA-35 amplifier.

When mounting the Dynatuner in a panel or cabinet, consideration must be given to adequate air flow, particularly if other heat-producing devices, such as amplifiers, are also in the same area. *In restricted space, and particularly if the tuner must be mounted face up, it is essential that a small circulating fan be used.* The warranty on the Dynatuner is void if it has been abused through inadequate ventilation.

It is simple to install the Dynatuner in any panel up to 1" in thickness. A supporting shelf should be installed flush with the bottom of a  $13\frac{1}{16}$ " x  $3\frac{1}{16}$ " cutout, and the rubber feet are not used. A PBK bracket kit is available from Dynaco for \$2, which takes the place of the shelf. No C.O.D.s please. If it is desired to mount the Dynatuner and the Dyna PAS-3 in a single cutout, the rubber feet are used on the tuner, which is mounted above the preamp, and the cutout should be made  $7\frac{1}{16}$ " high by  $13\frac{1}{16}$ " wide.

### TECHNICAL DESCRIPTION

The circuit features which distinguish the FM-3 can be described only in somewhat technical terms. Those not interested in the technology may ignore this section.

The FM-3 has the following basic tube and circuit sequence:

1. A cathode coupled tuned R.F. amplifier using a 6AQ8/ECC-85 dual high frequency triode.

2. An oscillator-mixer stage using a 6AT8A high conversion triode-pentode with screen injection.
3. Four I.F. amplifier stages with progressive limiting using two 6BA6 pentodes and two 6AU6 pentodes.
4. A symmetrical wide band discriminator with matched semi-conductor diodes.
5. A cathode follower providing discriminator isolation and low impedance source to the multiplex and audio channels using one-half of a 12AX7/ECC-83.
6. A feedback audio amplifier using one-half of a 12AX7/ECC-83.
7. A 19KC amplifier and doubler using a pentode-triode 6BL8/ECF-80.
8. A balanced bridge synchronous detector using four matched semi-conductor diodes.
9. Stereo audio output stages consisting of feedback plate followers using a 12AX7/ECC-83.
10. A dual indicator EMM-801 acts as a tuning eye and as a stereo indicator.
11. The power supply, which uses a 6V4/EZ-80 full wave rectifier.

### **The Antenna Circuit**

Provision is made to match either a 75 ohm unbalanced or a 300 ohm balanced transmission line, thus accommodating any standard antenna array used for FM reception.

### **The R.F. Stage**

The cathode coupled dual triode R.F. amplifier circuit was chosen for the input stage. It combines the high gain and low noise figures of the commonly used grounded grid input with a tuneable input—a necessary feature to prevent overloading from strong signals which might cause cross-modulation and spurious responses.

### **The Oscillator-Mixer**

The triode section of the 6AT8A is used in a “tickler feedback” tuned grid oscillator circuit. Careful temperature stabilization and choice of operating parameters result in an oscillator circuit with sufficient stability to obviate any need for automatic frequency control with its inherent degradation of the audio signal.

The pentode section of the 6AT8A is used as the mixer. The oscillator is injected into the screen circuit to provide complete isolation of the oscillator tuning circuit from the signal tuning circuit at the mixer grid. Oscillator drag (change in oscillator frequency as the mixer tuning is adjusted) is virtually nonexistent, greatly simplifying the adjustment and tracking of the front end. This isolation also reduces re-radiation of the oscillator energy into the antenna which might cause interference in other nearby receivers and television sets.

Circuit constants of the oscillator and mixer circuits have been adjusted to give uniform sensitivity over the entire FM band.

### **The I.F. Amplifiers and Limiters**

Phase shift in an FM signal corresponds to amplitude non-linearity or distortion in an AM signal or in an audio amplifier. Accordingly, the I.F. amplifier circuits were designed for minimum phase shift across the pass band. Since this occurs with undercoupled transformers, the alignment of the I.F. section is greatly simplified. Simple peak tuning (tuning for maximum signal) is the optimum adjustment for the undercoupled I.F. transformers. This minimum phase shift approach maintains low distortion of

the audio signal all the way down into the noise and permits useful reception of weak signals even without full limiting action.

A 6BA6 variable- $m\mu$  pentode is used for the first and second I.F. stages, and 6AU6 sharp-cutoff pentodes are used for the succeeding two stages. Each I.F. stage acts as a limiter when the signal input to that stage reaches a pre-determined point. Thus no automatic volume control circuit is needed and no additional recovery time constants exist to introduce delay on fading signals. There is sufficient gain in the receiver so that the last limiter is effective on input noise.

### **The Discriminator**

A symmetrical discriminator configuration is used in place of the conventional unbalanced circuit. This circuit balances out any noise and signal rectification occurring in the plate circuit of the last limiter tube and is the key to the phenomenally low distortion figures achieved by the Dynatuner. A wide band discriminator transformer and matched semi-conductor diodes are used to obtain the full benefit of this design.

The balancing action of this circuit reduces the inter-channel noise (between stations) by a factor as great as 10 db in level over many conventional tuners which use limiter-discriminator circuits.

The discriminator signal goes first through one-half of a 12AX7 functioning as a cathode follower and then through the second half of this stage which is used as an audio amplifier with plate to grid feedback. The output of the cathode follower also is used as a source to a portion of the multiplex circuitry.

### **The Multiplex Integrator**

The first portion of the multiplex section is fed from the cathode follower. This signal is Q-multiplied and amplified at 19KC in the pentode half of the 6BL8. Then it is further amplified and doubled to 38KC in the triode section of this tube. This triode section also acts as a limiter, holding a constant 38KC level regardless of signal strength and pilot amplitude. Such limiting greatly reduces noise through the stereo “gates” and preserves equally good separation at all level signals.

The audio signal from the plate circuit of the 12AX7 is shaped in a 67KC band reject filter. Then it is mixed with the reconstructed 38KC signal in a balanced transformer. A four-diode bridge provides synchronous detection of left and right channels which then are passed through a combined 38KC rejection filter and audio de-emphasis network.

A signal from the 19KC amplifier section is used to activate the upper beam of the EMM-801 tuning eye which illuminates the word STEREO when there is a stereo transmission.

The action of the multiplex section is automatic as the 38KC channel is quenched in the absence of a pilot signal from the broadcast station. However, it can also be shifted to locked mono reception by use of the push-pull Stereomatic-mono switch which can deactivate the automatic stereo feature.

### **The Audio Section**

A 12AX7 is used for audio output, with one half for each stereo channel. This tube has plate-to-grid feedback and is used as a plate follower. It has low impedance output, permitting up to 25 feet of shielded cable. It has very low distortion and minimum frequency discrimination.

## GENERAL WIRING PRACTICE

When you unpack the kit, first check the components against the parts list. You can identify unfamiliar components by matching them to parts illustrated in the pictorial diagrams supplied.

Have the proper tools at hand before beginning to build your kit. You will need a pencil-type soldering iron of 30- to 60-watt rating; long-nosed pliers; diagonal cutters; and a screwdriver. If you have a soldering gun, it should be used with care, especially when working on the circuit board, because of its higher than necessary heat output. Although not essential, a wire-cutting and stripping tool will help considerably; these are available for less than a dollar.

The only procedure involved in building a Dynakit which requires a bit of technique is soldering, and this is quite easy to master. There are four steps to making a good solder connection:

1. Make a good mechanical connection.
2. Heat both parts of the connection with the iron.
3. Apply solder to the connection until it melts and runs.
4. Allow the connection to cool undisturbed.

### ALL SOLDERING MUST BE DONE WITH ROSIN CORE SOLDER.

There is no warranty on any equipment in which acid core solder has been used. Make sure that the solder you use is plainly marked "ROSIN CORE." Do not use cheap solder or solder of doubtful origin. Recommended solder is 60/40 (60% tin, 40% lead) rosin core.

Whenever one (1) wire is to be soldered to a connection, the instructions will indicate this by the symbol (S). When two (2) wires are to be soldered to a connection, the symbol (S-2) is shown; when three (3) wires are to be soldered, the symbol (S-3) appears, etc. There may be as many as five (5) wires to be soldered to a connection. If no symbol is shown, do not solder; further wiring will be made to that connection before soldering.

Components can be identified by comparison with the pictorial diagrams. Capacitors are individually marked. Resistors will be marked either with their values, or with the color code specified in the instructions. The first color is nearest the end of the resistor, and any fourth color band may be ignored.

A number of steps in the instructions begin, "Connect one end of a wire . . .", with the length of the wire specified. In each case, first cut a piece of wire to the correct length from the roll supplied with the kit, and then remove about  $\frac{1}{4}$ " of insulation from each end before making the connection. The leads on components should be trimmed as they are used, the length chosen being that which permits a connection to be made from point to point without strain on terminals or components. The position of all wire leads should follow that shown in the pictorial diagram as closely as possible. Care must be exercised to see that uninsulated wires do not touch each other, and cannot do so through vibration or sagging, unless, of course, they are connected to the same point. It is especially important that uninsulated wires and component leads or terminals do not touch the chassis or bottom plate accidentally.

Check your work after each step, and, when you are satisfied that it has been correctly done, mark the space provided and go on to the next step. Examine the pictorial diagrams often; if you check your work methodically, your Dynakit should work as soon as the wiring is complete.

One of the best ways to make a good mechanical connection is to bend a small hook in the end of a wire, and then to crimp this hook onto the terminal to be connected. The amount of bare wire exposed at the end need not be exactly  $\frac{1}{4}$ -inch; however, if it is too long, there is danger of the excess touching another terminal or the chassis. There is no need to wrap the wire around the terminal more than one time, as this makes a connection that is much more difficult to remove if an error has been made.

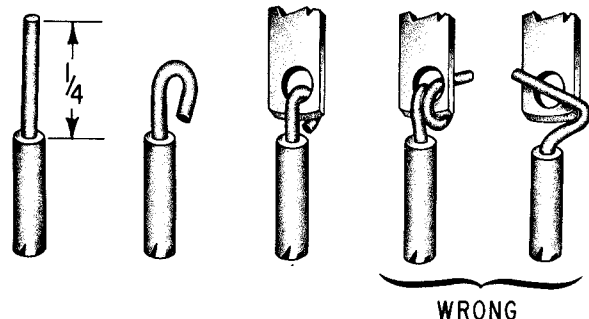

To transfer heat from the iron to the wire and terminal, the tip of the iron should be kept brightly tinned with solder. If this is properly done the first time the iron is used, the tinning may be maintained by wiping the tip with a cloth or sponge every few minutes while soldering. When correctly tinned, the tip will heat both parts of the con-

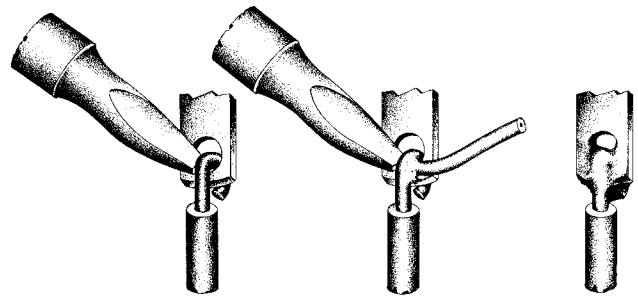

nection almost immediately. Solder should then be applied directly to the parts to be soldered, as shown in the middle illustration above, and both iron and solder removed as soon as the solder flows freely.

When soldering a part to the etched circuit board, the solder must completely surround the wire lead where it comes through the board. Do not apply excessive solder, but do not hesitate to apply sufficient heat to assure a smooth flow of solder all around the lead and onto the board.

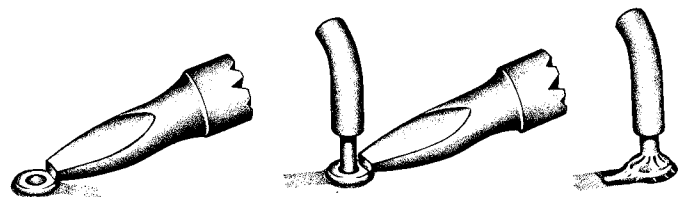

The circuit boards are connected to other sections of the Dynatuner by soldering wires to eyelets on the boards. To solder a wire to these numbered eyelets, first "tin" the bared wire by heating it with the iron and flowing solder over it. Insert the wire into the eyelet, and heat both the eyelet and the wire while applying solder to the junction. A correctly made connection looks like the illustration at the right, above, which shows a smooth transition from the eyelet to the wire and to the board.

## ASSEMBLY INSTRUCTIONS

You will first assemble the three etched circuit boards PC-7, PC-8 and PC-12, and then mount these and other components on the chassis and complete the wiring. The use of protectively coated circuit boards in the Dynatuner, on which most of the components are mounted, greatly simplifies assembly of the kit, and contributes considerably to its outstanding performance. Close attention to the suggestions made here will enable you to realize the fullest capabilities of the Dynatuner.

On each etched circuit board all of the component positions are diagrammed on the top of the board (the side without the copper). The identification symbol for each component is marked between the holes into which its leads will be inserted. Resistors may be identified from the color code on the parts list. The first color stripe is nearest the end of the resistor. Any fourth color stripe may be ignored. Each capacitor is marked with its value and any special characteristics. Other special components will be identified as they are called for in the assembly process. To speed assembly, it is suggested that you first compare the components with the parts list and sort them accordingly. The edge of a corrugated box makes a handy storage rack for resistors and small capacitors.

Before starting assembly of the etched circuit boards, observe detail A. A GOOD SOLDERING JOB IS ESSENTIAL TO THE SATISFACTORY PERFORMANCE OF YOUR TUNER. Soldering to etched circuit boards is easier than conventional point-to-point wiring when it is done correctly. The copper side of each Dynatuner board is coated with a corrosion inhibitor which is also conducive to soldering, but there is no substitute for good soldering technique.

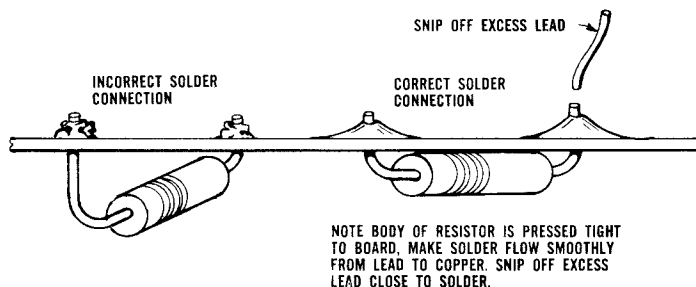

DETAIL A

Be sure that enough heat reaches both the copper on the board and the wire to be soldered to make a smooth solder junction. When making connections to the eyelets, be sure that the solder flows from the wire to the board, across the eyelet, so that the eyelet is soldered to the wire and to the board at the same time. The insulating wax or enamel used on the leads of some components (capacitors, chokes) may prevent good contact when these leads are soldered, if all of the insulation has not been removed from that part of the lead which is to be soldered. Avoid getting solder on the outer  $\frac{3}{8}$ " edge of the boards. This area contacts the chassis when the boards are installed and solder splashes here will prevent uniform contact, stressing the board.

## ASSEMBLY OF THE R.F. CIRCUIT BOARD PC-7

- 1 ( ) Position the PC-7 etched circuit board in front of you as in the pictorial diagram. Support the board over an open box or between two objects so that the leads from the components may project through. Insert all of the one-half watt resistors in their places on the circuit board. To bend the leads of each resistor to the correct shape, hold the resistor between the thumb and forefinger of one hand and bring the thumb and forefinger of the other hand just across the ends of the body, bending the leads as in detail B. It will help in rechecking your work to orient the color codes of all resistors uniformly. Spreading the leads slightly after installation will hold the resistors flush to the board, so that they will stay in place when the board is inverted for soldering. Solder each lead with a small amount of solder. The solder should flow smoothly all around the lead on to the copper. Cut off all excess leads. Be careful not to allow the lead to form a bridge to another portion of the circuit.

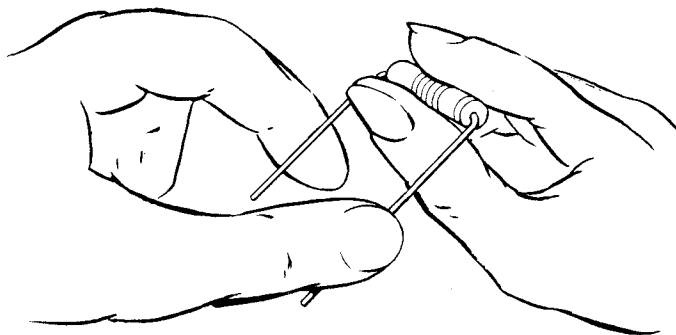

DETAIL B

After soldering, there should be no space between the bodies of the resistors and the top of the PC board. If there is, the resistor should be gently pressed to the board while the soldered leads are reheated, until the resistor is flush with the board. This also applies to other components mounted in the following steps.

- 2 ( ) Insert the 3.9 microhenry choke L2 and the heater choke L5. Insert all the one watt resistors. *Do not confuse the larger 2 watt, 10,000 ohm resistors to be used on PC-8 with the one watt resistors used here.* Insert the 2.2 mmfd tubular capacitor C11 (red-red-white-gray dots). Invert the board, solder each lead of these components and trim off the excess.
- 3 ( ) Insert the two 9 pin sockets V1 and V2. Note the location of the flat side of each socket. *Be certain that each tab goes into its hole and does not bend over on top of the board.* Seat each socket firmly to the board and then solder each pin *and* the center ground pin.

- 4( ) Refer to the pictorial diagram, the parts list for PC-7, and the values marked on the individual capacitors. Insert all the disc capacitors as shown in detail C. Make certain that the body of each capacitor touches the board. Bend the leads slightly to prevent them from falling out when the board is inverted for soldering. Solder all leads.

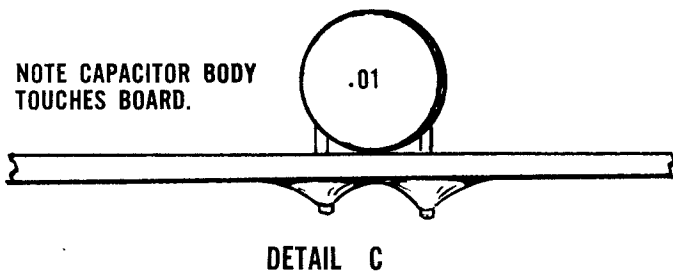

- 5( ) Mount the oscillator coil L4 (the one with four leads at the bottom) in the group of four holes indicated. The two heavier leads are inserted in eyelets #10 and #11. Mount the mixer coil L3 (the one with only two leads at the bottom and none at the top) in eyelets #7 and #8. Be sure it is oriented as shown in the pictorial diagram. See that each coil form is seated firmly to the board and solder all six coil leads; the eyelets *must* be firmly soldered to the coil leads *and* to the copper foil.

#### MOUNTING CAPACITOR C8

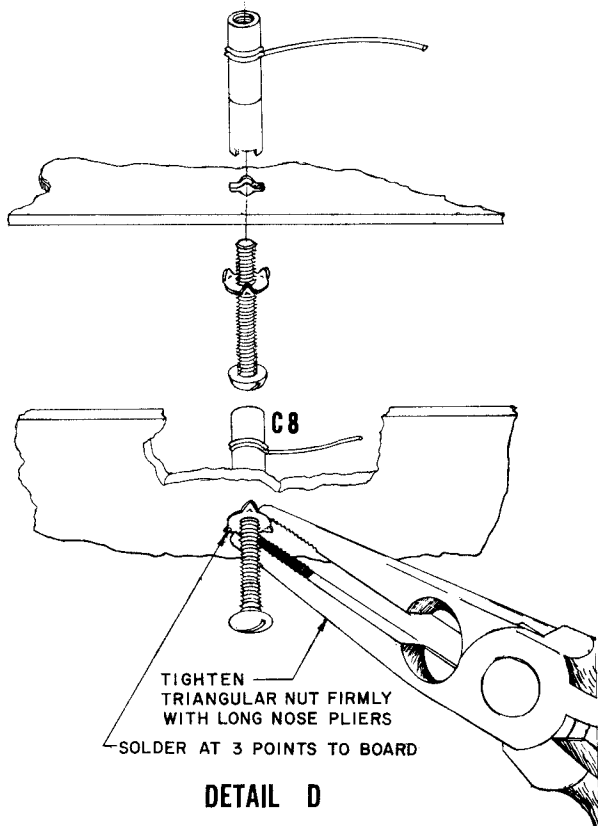

- 6( ) The oscillator trimmer capacitor C8 is a white tubular ceramic form with a #6 screw and triangular nut. The nut is supplied threaded onto the  $\frac{3}{4}$ "

screw in the hardware bag. Be sure that the points of the nut face away from the screw head, and run the nut out on the screw so that it is at least  $\frac{1}{2}$ " from the head. Insert the tabs of the capacitor into the matching cutout on the board. Note the location of the wire lead. Hold the capacitor firmly against the board, and turn the screw in from the bottom (see detail "D") until the triangular nut is firmly seated. Now tighten the nut with long-nosed pliers, while pressing the capacitor to the board. The points of the nut must dig into the copper so that the capacitor mounting is absolutely rigid. Solder the nut to the board at the three points. Insert the top lead of the capacitor into the hole indicated in the pictorial, keeping it as short as possible, and solder the lead.

- 7( ) Mount the special temperature compensating capacitor C7 (2.55 mmfd N2200, with six color stripes) as shown in the pictorial. *Make sure it is seated snugly against the board and against the tube socket*. Solder both leads.

- 8( ) Mount the I.F. transformer T1 (one of the four marked 432001) on the board. Note the indicator (a slot or color marking) in one corner of the top of the can. Be sure to mount the transformer with this indicator oriented as shown in the pictorial. The transformer should snap into place and seat firmly against the board. Solder the mounting tab next to C12 first, but do not solder the other mounting tab. Solder each of the four connecting lugs. Avoid excessive heat, but be sure a good connection is made. Do not use too much solder, to prevent any excess from running into the transformer and damaging it.

- 9( ) Observe the direction of the offset in the ground straps as shown in the pictorial diagram. Insert the ground straps into their slots in each of the tube sockets. Solder both to the board.

- 10( ) Insert a round toothpick or similar instrument into eyelets #2 and #4 from the bottom of the board. The purpose of this is to prevent solder from filling these eyelets. Now solder the eyelets to the copper on the board and remove the toothpick. (These eyelets may already have been soldered when you receive the board.) Be certain a good connection is made all around each eyelet as this will be difficult to check later. Insert the two heavy leads of the antenna coil L1 into eyelets #2 and #4. Note that this coil is mounted on the *bottom* of the board, and is oriented to align the center slug with the hole in the board. Solder the two leads to the eyelets on the *top* of the board. It may be necessary to scrape the coil leads, or to ream the eyelets slightly if the inside of the eyelet is not perfectly free of solder, as this is a very snug fit.



## ASSEMBLY OF THE I.F. CIRCUIT BOARD PC-8

- 1( ) As before, support the board on an open box or between two objects so that the leads may project below the board as you insert components. Insert all of the one-half watt resistors, after bending their leads as before. Be sure all the resistors are seated firmly against the board. Turn the board over and solder all of the leads. Cut off the excess.
- 2( ) Insert the one watt resistor R22, the two watt resistors R11 and R13, and the four heater chokes L6, L7, L8 and L9. Solder these in place and trim off the excess leads.
- 3( ) Mount the four seven pin sockets V3, V4, V5 and V6. Note the orientation of the flat side of each socket. *Be sure each pin penetrates the board and does not bend over on top of the board.* Make sure that each socket is seated firmly against the board and then solder all seven pins and the center ground pin of each socket.
- 4( ) Mount the nine pin socket V7. *Be sure each pin penetrates the board and does not bend over on top of the board.* Seat it firmly, and solder all nine pins and the center ground pin.
- 5( ) Install capacitors C29 and C31. Solder all four leads and cut off the excess.
- 6( ) Install all of the disc capacitors. As before, the leads of these capacitors may be bent slightly to hold them in place, but be careful that no "bridges" are formed to adjacent parts of the circuit. Solder all leads and cut off the excess.
- 7( ) Install PEC 555004, making sure that is correctly oriented. Solder all three leads and cut off the excess.
- 8( ) Insert the remaining I.F. transformers T2, T3 and T4 (all 432001). Follow the location of the indicator at the top of each transformer as shown in the pictorial. Solder both tabs and all four lugs on each transformer. Avoid excessive solder, which may flow into the transformer and damage it. The discriminator transformer T5 will be mounted later.
- 9( ) Note the orientation of the offset in the ground straps and install them in each tube socket. Solder these ground straps.
- 10( ) Install the pilot light socket. Observe that the connecting tab from the socket center contact goes into the hole adjoining eyelet #20. *Do not install it backwards!* Solder both tabs.

## ASSEMBLY OF THE MULTIPLEX BOARD PC-12

- 1( ) Insert the one-half watt resistors R71 through R93 in their places on the board after bending their leads as before. Solder all leads and cut off the excess.

- 2( ) Insert capacitors C71 through C84 in their places on the board. Solder all leads and cut off the excess.
- 3( ) Insert the two 9-pin sockets V71 and V72. Note the orientation of the flat side of each socket. *Be sure each pin penetrates the board and does not bend over on top of the board.* Seat each socket firmly to the board and then solder all nine pins on each socket. *Do not solder the center ground pin on either socket at this time.*
- 4( ) Install the small wooden wedge under the choke L71, and install L71 so that the thick part of the wedge is adjacent to C81 when the choke leads are inserted into the board. Solder both leads and cut off the excess.
- 5( ) Mount the transformers T71 and T72 (432003). Be careful to orient these correctly. *Make certain that the indicator on top of the transformer coincides with the heavy dash on the board and with the pictorial.* These transformers must be seated firmly against the board, and the two mounting tabs should snap into place. Solder both mounting tabs and all four lugs on each transformer.
- 6( ) Mount transformer T73 (432004). Note that this transformer can be mounted only one way. Seat it firmly so that it snaps into position, and make certain that all 5 connecting lugs, as well as the two mounting tabs, penetrate the board. *Do not solder lugs #2 and #3 as shown in the pictorial.* Solder both mounting tabs and the other three lugs.
- 7( ) Mount PEC-1 and PEC-2 (555001). *Note that these identical units face in opposite directions.* Solder all 6 leads and cut off the excess.
- 8( ) Note the orientation of the offset in the ground straps and install them in each tube socket. Solder these ground straps.
- 9( ) Observing detail E, mount each of the four diodes D71 through D74. Those supplied may look like either of those in the illustration, and will have one end painted red, or marked with three stripes. (Disregard single green dots or stripes.) DIODE POLARITY IS IMPORTANT. The arrowheads on the PC-12 board point to the *marked* ends of the diodes. Diodes should be soldered carefully using the following technique: The leads should be bent up, and looped down in the manner shown to provide a "heat sink." When soldering them, grasp the loop with a pair of pliers from the top of the board to absorb any excess heat, and solder from the bottom of the board. This technique prevents damage to the relatively delicate diodes from excessive heat.

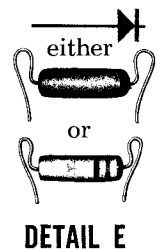

This completes the assembly of the etched circuit boards. Your FM-3 is now almost half completed.

## CHASSIS ASSEMBLY

- 1( ) Install the on-off switch inside the front flange of the chassis, noting the position of the lugs in the pictorial diagram. Use two #4 (smallest nickel-plated) screws. Lockwashers and nuts are not necessary as the holes in the switch are threaded.
- 2( ) Install the three screw terminal strip with two sets of #4 hardware. The screws go through the strip first, which is mounted on the *outside* of the rear flange of the chassis. Refer to the pictorial for proper orientation of the lugs. Secure it with a lockwasher under each nut.
- 3( ) Insert the fuse holder into the special D shaped hole. Note the orientation of the lugs. The rubber washer fits between the shoulder and the outside of the chassis. Fasten in place securely with its lockwasher and nut, but do not tighten excessively.
- 4( ) Install the AC outlet with two sets of #4 hardware.
- 5( ) Install the two audio output sockets on the *inside* of the chassis using two sets of #4 hardware for each. Note the orientation of the ground (short) lugs in the pictorial.
- 6( ) Install one of the two nine pin sockets which have mounting flanges, in the center of the chassis. Note the location of the blank space between the pins in the pictorial. The socket is mounted on *top* of the chassis with two sets of #4 hardware.
- 7( ) Install the 3 rubber grommets. The larger one is inserted into the line cord hole at the rear of the chassis, and the other two are fitted into the holes in the dividing partition in the middle of the chassis.
- 8( ) Hold the PC-7 board as shown in the pictorial, with the I.F. transformer away from you, and carefully pick up the tuning capacitor C1, holding it so that the shaft points away from you. Be particularly careful that you do not touch the semicircular copper and aluminum colored plates of the capacitor. If these are bent, even slightly, it will be difficult to get the tuner to track accurately across the dial when you come to the alignment procedure. Now insert the small tabs which protrude from the bottom of C1 into the corresponding five holes in the top of PC-7. *Be careful capacitor C7 is not damaged.* This fit is especially snug, but be sure that the tuning capacitor is *fully seated* against the board. Two of the threaded studs of the capacitor will also engage the board. The shoulders of these studs should seat against the board.
- 9( ) Mount the PC-7—C1 assembly on the top of the chassis, locating it by the four threaded studs of C1. Install four sets of #6 (medium size) lockwashers and nuts on these studs but do not tighten them.
- 10( ) Fasten the PC-7 board in place with five sets of #4 (smallest size nickel plated) hardware. Install the screws from the top, and secure with a lockwasher under each nut. Tighten these, and also tighten the nuts on the capacitor studs.
- 11( ) Install the tuning capacitor shield, using three sets of #4 hardware. *Make sure that capacitors C6 and C7 do not touch the shield.* The tab of the shield is fed through the hole in PC-7 for the mounting tab of T1. Solder both of these tabs to the board. Be certain that no bare leads contact the shield.
- 12( ) Install the I.F. circuit board PC-8 on the *top* of the chassis. Fasten with eight sets of #4 hardware.
- 13( ) Install the multiplex circuit board PC-12 on top of the chassis using four sets of #4 hardware. Follow the orientation in the pictorial diagram.
- 14( ) Feed all the power transformer (PA-509 or PB-012) leads through the one-half inch hole as shown in pictorial. Position the five lug terminal strip over the power transformer mounting hole in the chassis between the hole for the transformer leads and the nine pin tube socket. Note the orientation of the lugs in the pictorial. Fasten this corner of the transformer and the terminal strip with #8 hardware (the largest size). Use #8 hardware to fasten the remaining three corners of the transformer to the chassis. Be sure all transformer mounting bolts are tight, and recheck all other hardware to make sure that all components are securely in place.
- 15( ) Mount the filter capacitor C32 in the center of the chassis. Note the identifying marks at each lug of the capacitor (semi-circle, square, triangle, and blank) and orient the capacitor according to the pictorial diagram. Fasten it rigidly in position by twisting the four mounting lugs  $\frac{1}{4}$  turn with a pair of pliers.

## WIRING THE FRONT PANEL SUB-ASSEMBLY

Unless otherwise specified, the insulation should be stripped from each length of wire for a distance of  $\frac{1}{4}$ " at each end prior to installation.

- 1( ) Mount the tuning eye socket V8 (with mounting flange) on the front panel with two sets of #4 hardware. Note that it is installed with the blank space between pins #1 and #9 at the top of the panel. The mounting flange is flush with the bracket if the socket is mounted correctly.
- 2( ) Strip the insulation back  $\frac{1}{2}$ " from one end of a  $2\frac{3}{4}$ " black wire. Remove the normal  $\frac{1}{4}$ " of insulation from the other end. Feed the  $\frac{1}{2}$ " bare end through pin #3 of socket V8 and connect it to pin #1. Keep it clear of pin #2. Solder pins #1 and #3. Position this wire under the right-angle mounting bracket for V8 and close to the front panel.
- 3( ) Connect one end of an  $8\frac{1}{2}$ " red wire to pin #6 of socket V8 (S).
- 4( ) Connect one end of an 8" green wire to pin #7 of V8 (S).
- 5( ) Place the  $\frac{3}{8}$ " lockwasher on the shaft of the volume control assembly and mount the assembly in the front panel. Locate the lugs as shown in the pictorial diagram. Fasten with the  $\frac{3}{8}$ " nut.

- 6( ) Cut a 4½" black wire. Strip one end ¾" and feed it through lug #1 of the volume control and connect it to lug #4 of the control.
  - 7( ) Connect one end of an 8½" black wire and one end of a 5½" black wire to lug #4 of the control (S-3).
  - 8( ) Connect one end of an 8½" green wire to lug #5 of the control (S).
  - 9( ) Connect one end of a 2½" green wire to lug #6 of the control (S).
  - 10( ) Twist together an 8" black and an 8" red wire. Connect one end of the black wire to lug #1 of the control (S-2). Connect the corresponding end of the red wire to lug #2 of the control (S).
  - 11( ) Connect one end of a 3" red wire to lug #3 of the control (S).
  - 12( ) Twist together the red wire from lug #3 and the green wire from lug #6 of the control. Connect the red wire to lug #1 of the switch. Connect the green wire to lug #2 of the switch.
  - 13( ) Connect one end of a 5" red wire to lug #1 of the switch (S-2).
  - 14( ) Connect one end of a 4" green wire to lug #2 of the switch (S-2).
  - 15( ) Position the shorter (5½") black wire from lug #4 of the control across the switch bracket and twist it together with the red wire from switch lug #1 and the green wire from switch lug #2. These wires will be soldered to eyelets on PC-12 later.
  - 16( ) Cut two red wires each 6½" long and twist them together. Connect one end of one wire to switch lug #4 (S). Connect the corresponding end of the other wire to switch lug #5 (S).
- 5( ) Connect the green power transformer lead to lug #2 of the five lug terminal strip. Note that the lead is inserted into the *lower* hole of the lug (S). Solder to this lower hole of the lug only. The top section of the lug will be soldered later.
  - 6( ) Connect the green-white power transformer lead to lug #3 of the five lug terminal strip. This lead is inserted into the *lower* hole of the lug (S). Solder to this point on the lug only. The top section of this lug will be soldered later.
  - 7( ) Twist together the two black power transformer (PA-509) leads. Connect one lead to lug #2 of the AC outlet. Connect the other lead to lug #2 of the fuse holder (S).
  - 8( ) Connect one end of a 1½" green wire to lug #2 of the five lug terminal strip. Connect the other end to pin #4 of socket V9 (S).
  - 9( ) Connect one end of a 1½" black wire to lug #3 of the five lug terminal strip. Connect the other end to pin #5 of socket V9 (S).
  - 10( ) Connect one end of a 500 ohm 5 watt resistor to lug #1 (semi-circle symbol) of the filter capacitor C32. Connect the other end to lug #2 (square symbol) of the capacitor.
  - 11( ) Connect one end of a 2" red wire to pin #3 of socket V9 (S). Connect the other end to lug #1 of the filter capacitor C32 (S-2).
  - 12( ) Connect one end of the other 500 ohm 5 watt resistor to lug #2 of the filter capacitor C32 (S-2). Connect the other end to lug #3 (triangle symbol) of the capacitor.
  - 13( ) Connect one end of a 470 ohm (yellow-violet-brown) one watt resistor to lug #3 of the filter capacitor C32. Connect the other end to lug #4 (no symbol) of the capacitor.

NOTE: If you are using the optional 120/240 volt power transformer PB-012, replace this step with the steps specified on Page 19.

This completes the front panel sub-assembly. Set this aside.

### CHASSIS WIRING

- 1( ) Strip a 2½" piece of wire bare. Feed one end through the rear tab of the tuning capacitor C1 that projects through the steel chassis, and then through the other tab, and over to the first tab that projects through the PC-7 board. See pictorial. Solder all three points and trim off the excess. It is not essential that the wire be soldered to the chassis at the two points, but a good bond to the etched circuit board is essential.
  - 2( ) Solder all four of the remaining connecting lugs of the tuning capacitor which project through PC-7.
  - 3( ) Twist together the two red and the red-yellow power transformer leads. Connect one red lead to pin #1 of socket V9 (S). Connect the other red lead to pin #7 of socket V9 (S). Connect the red-yellow lead to ground lug A on filter capacitor C32.
  - 4( ) Connect one end of a 2½" black wire to lug #3 of the five lug terminal strip. Connect the other end to ground lug A on filter capacitor C32 (S-2).
- The following steps will refer to eyelets on the etched circuit boards. Always be certain that you are connecting to the correct point. The electrical requirements of the layout of the circuit board, combined with the tight space allowance, may lead to confusion unless the relationship of numerals and eyelets is carefully observed.
- Remember that when soldering to an eyelet, a smooth well-soldered connection must be made from the wire to the eyelet, and from the eyelet to the copper on the board. Connecting to an eyelet is easier if the wire is "tinned" first by heating it with the iron and applying a light coating of solder to the bared end.
- 14( ) Connect one end of a 3½" green wire to eyelet #1 on PC-7 (S). Connect the other end to eyelet #5 (S). Position this wire as in the pictorial.
  - 15( ) Connect one end of a 6¾" green wire to eyelet #6 on PC-7 (S). Connect the other end to eyelet #13 on PC-8 (S).
  - 16( ) Connect one end of a 3" green wire to eyelet #14 on PC-8 (S). Connect the other end to eyelet #17 (S).

- 17( ) Connect one end of a 6" green wire to lug #2 of the five lug terminal strip. Feed this wire through grommet #1, and connect the other end to eyelet #18 on PC-8 (S).
- 18( ) Connect one end of a 3" green wire to eyelet #19 on PC-8 (S). Connect the other end to eyelet #24 (S).
- 19( ) Connect one end of a 6½" green wire to eyelet #20 on PC-8 (S). Feed the wire through grommet #1 and connect the other end to lug #2 of the five lug terminal strip.
- 20( ) Connect one end of a 6" green wire to eyelet #35 on PC-8 (S). Feed the wire through grommet #2 and connect the other end to lug #4 of the five lug terminal strip.
- 21( ) Connect one end of a 9" red wire to eyelet #9 on PC-7 (S). Connect the other end to eyelet #15 on PC-8 (S).
- 22( ) Connect one end of a 4½" red wire to eyelet #16 on PC-8 (S). Connect the other end to eyelet #21 (S).
- 23( ) Connect one end of a 4¼" red wire to lug #3 of the filter capacitor C32. Feed the wire through grommet #1 and connect the other end to eyelet #22 on PC-8 (S).
- 24( ) Connect one end of a 7" red wire to lug #3 of the filter capacitor C32 (S-4). Feed the wire through grommet #1 and connect the other end to eyelet #27 on PC-8 (S).
- 25( ) Connect one end of an 8" red wire to lug #4 of the filter capacitor C32. Feed the wire through grommet #2 and connect the other end to eyelet #34 on PC-8 (S).
- 26( ) Connect one end of a 5½" red wire to lug #4 of the filter capacitor C32. Connect the other end to eyelet #12 of PC-7 (S).
- 27( ) Connect one end of a 7½" red wire to lug #4 of filter capacitor C32 (S-4). Thread this wire under the transformer leads. Connect the other end to eyelet #87 on PC-12 (S).
- 28( ) Connect one end of a 1½" red wire to eyelet #36 on the bottom of PC-8 (S). Connect the other end to eyelet #38 (S).
- 29( ) Connect one end of a 6½" black wire to eyelet #40 on PC-8 (S). Connect the other end of this wire to eyelet #73 on PC-12 (S).
- 30( ) Connect one end of a 6" green wire to eyelet #33 of PC-8 (S). Connect the other end to eyelet #72 on PC-12 (S).
- 31( ) Connect one end of a 4" green wire to eyelet #39 on PC-8 (S). Connect the other end to eyelet #71 on PC-12 (S).
- 32( ) Connect one end of a 2" green wire to eyelet #81 on PC-12 (S). Connect the other end to the center (long) lug of output socket A (S).
- 33( ) Connect one end of a 1¼" green wire to eyelet #85 on PC-12 (S). Connect the other end to the center (long) lug of output socket B (S).
- 34( ) Twist together an 8" black wire and an 8" green wire. Thread these wires through the small slot in the front of the chassis, and through grommet #2. Connect the black wire to lug #3 of the five lug terminal strip. Connect the green wire to lug #4 of the five lug terminal strip.
- 35( ) Cut two 7" black wires. Connect one end of each wire to lug #3 of the five lug terminal strip. For convenient wire placement, insert one wire from the front, and one from the rear of the lug (S-5).
- 36( ) Connect one end of a 1½" green wire to lug #2 of the five lug terminal strip (S-4). Connect the other end to lug #4 of the terminal strip.
- 37( ) Cut two 7" green wires. Connect one end of each wire to lug #4 of the five lug terminal strip. For convenient wire placement, insert one wire from the front, and one from the rear of the lug (S-5).
- 38( ) Twist together the black and the green wires from the *front* side of the five lug terminal strip. Connect the black wire to the center ground pin of socket V71 (S). Be sure the center pin is soldered to the copper on the board. Connect the green wire to eyelet #74 (S). Position the wires as shown in the pictorial.
- 39( ) Twist together the black and green wires from the *rear* of the five lug terminal strip. Position the wires as shown in the pictorial, under the green wire to output socket A. Connect the black wire to the center ground pin of socket V72 (S). Be sure it is soldered to the board. Connect the green wire to eyelet #83 (S).
- 40( ) Place the body of the .02 mfd disc capacitor *under* the switch as shown in the pictorial diagram. Connect one lead of the capacitor to lug #1 of the on-off switch. Connect the other lead of the capacitor to lug #2 of the switch.
- 41( ) Twist together a 10" black wire and a 6½" black wire so that one pair of ends is even. Feed the pair through grommet #2 and connect one of the even ends to lug #1 of the on-off switch (S-2). Connect the corresponding end of the other wire to lug #2 of the on-off switch (S-2). Connect the other end of the longer wire to lug #2 of the AC outlet (S-2). Connect the other end of the shorter wire to lug #5 of the five lug terminal strip.
- 42( ) Connect one end of a 1¾" black wire to lug #1 of the AC outlet (S). Connect the other end to lug #1 of the fuse holder.
- 43( ) Strip a 1" piece of wire bare. Connect one end to eyelet #3 of PC-7 (S). Connect the other end to lug #2 of the three-screw terminal strip.
- 44( ) Connect the twisted wire from the center of the antenna coil L-1 to lug #2 of the three-screw terminal strip (S-2).
- 45( ) Connect the wire from each side of the antenna coil L-1 to the screw terminal nearest it. Follow the wire arrangement in the pictorial diagram. Solder both lugs #1 and #3.

- 46( ) Connect a 1" bare wire from eyelet #23 on PC-8 (S) to eyelet B (S). This jumper should be kept close to the board, but it must not touch adjacent circuitry.
- 47( ) Connect one end of a 3" red wire to eyelet #30 on the top of PC-8 (S). "Tin" the wire with solder first, and then *insert the wire from above as the eyelet is heated from below*.
- 48( ) Connect one end of a 2½" red wire to eyelet #28 on the top of PC-8 (S).
- 49( ) Connect one end of a 3" green wire to eyelet #26 on the top of PC-8 (S).
- 50( ) Slide the tuning dial indicator disc *fully* onto the tuning capacitor shaft. The hub goes on the shaft first, and its flat side engages the flat portion of the shaft. Be sure the disc is pushed on to the full depth of the flat.
- 51( ) Temporarily demount the volume control assembly from the front panel and set it to one side.
- 52( ) Position the front panel sub-assembly adjacent to the front of the chassis. Take the green and black twisted pair of wires which protrude from the small slot in the chassis. Connect the black wire to pin #4 of V8 (S). Connect the green wire to pin #5 of V8 (S).
- 53( ) Thread the red and green wires from pins #6 and #7 of V8 through the small slot in the front of the chassis and through grommet #2.
- 54( ) Mount the front panel to the chassis using three sets of #4 hardware.
- 55( ) Connect the black wire from pin #3 of socket V8 to eyelet #25 on top of PC-8 (S).
- 56( ) Connect the red wire from eyelet #30 to pin #2 of socket V8 (S). Access to pin #2 can be gained through the front panel cutout. Position this wire flat against the board, and over to the front panel.
- 57( ) Connect the red wire from eyelet #28 to pin #8 of V8 (S).
- 58( ) Position the green wire from eyelet #26 under the V8 mounting bracket, and connect it to pin #9 of V8 (S).
- 59( ) Connect one end of a 1½" green wire to eyelet A of PC-8 on the top of the board. Solder it from the bottom of the board.
- 60( ) Connect the other end of the 1½" green wire from eyelet A of PC-8 to the top of eyelet A on PC-7 (S).
- 61( ) Slide the ⅜" lockwasher on the volume control shaft, and mount the assembly on the front panel, positioning the lugs as in the pictorial, but do not tighten the ⅜" nut. Be careful of the disc capacitors on PC-8.
- 62( ) Connect the short black wire from lug #1 of the volume control to eyelet #37 on PC-8 (S). A quantity of solder should be applied to eyelet #37 on the copper side of the board, and flowed over to the chassis to make a good ground contact to the chassis.
- 63( ) Twist together the remaining black wire from lug #4 of the control and the green wire from lug #5 of the control. Connect the black wire to eyelet #82 on top of the PC-12 board (S). Connect the green wire to eyelet #80 (S).
- 64( ) Take the red and black twisted pair of wires which are connected to lugs #1 and #2 of the control. Connect the black wire to eyelet #84 (S). Connect the red wire to eyelet #86 (S). Position the red-black and green-black pairs of leads from this and from the preceding step exactly as shown in the diagram, around V71, and away from T73. Keep them clear of the board.
- 65( ) Take the black, red and green twisted group of wires from the switch on the volume control assembly, and connect the black wire to eyelet #77 (S). Connect the green wire to eyelet #78 (S). Connect the red wire to eyelet #76 (S).
- 66( ) Thread the twisted pair of red wires from the switch through the slot in the chassis adjacent to PEC-1. On the underside of the board, connect these wires to lugs #2 and #3 of the transformer T73, as indicated in the diagram. Push the wire into the hole in the board alongside the transformer lug, and solder each to the lug and to the copper on the board. Note that this transformer has 5 connecting lugs positioned around the access hole. Be sure that the red wires are soldered to the proper points. Either wire may connect to either lug. Be sure that bare wire does not contact adjacent circuit points.
- 67( ) Observe the red and the green wires protruding through grommet #2. Connect the red wire to eyelet #79 on PC-12 (S). Connect the green wire to eyelet #75 (S). This green wire may appear long, but the extra length is used in the alignment procedure.
- 68( ) Mount the discriminator transformer T5 (432002). This transformer has five connecting lugs and two mounting tabs. It can be mounted in only one position. Press it firmly to the board and solder both mounting tabs and the five connecting lugs. *Do not use excessive heat on the five lugs*. Avoid using too much solder, which could flow into the transformer and damage it.
- 69( ) Insert the end of the line cord through grommet #3 in the rear of the chassis and pull through about 6 inches. Tie a knot 4 inches from the end, and pull the line cord back so that the knot seats against the grommet. Split the two conductors of the line cord down to the knot. Connect one of the two leads to lug #1 of the fuse holder (S-2). Connect the other lead to lug #5 of the five lug terminal strip (S-2). Now check to see that the black twisted pair, of which one wire connects to lug #5, is positioned away from PC-12.

This completes the assembly of your Dynatuner. You should now make one final inspection of the unit to see that all connections are soldered. One poor solder connection can upset the performance of your tuner, or prevent proper alignment. Be sure that there are no loose wire clippings or pieces of solder, and that there are no bridges of solder across insulated areas of the circuit boards.

Check to be sure that the position of the wires in your tuner agrees closely with the pictorial diagrams and with the photographs. The diagrams must sometimes be exaggerated for clarity, but any discrepancies between them and the photographs are of no consequence.

Insert the tubes into their sockets and install the dial lamp and the fuse. Install the tube shields, making sure that the ground strap of each socket slips between the tube and the shield. The larger shields go on the 9 pin tubes, and the smaller ones on the 7 pin tubes. V8 and V9 do not use shields.

There are two small brass-plated self-tapping screws which will be used to secure the aluminum front plate to the front panel. To avoid scratching the front plate, it is wise at this point to cut their threads into the holes above and below the tuning capacitor shaft by inserting these screws part of the way, and removing them. This will enable much easier insertion when the front plate is installed.

Remove the  $\frac{3}{8}$ " nut holding the volume control in position. Insert the rectangular plastic insert into the front plate cutout from the rear. The top edge is narrower than the bottom. Place the front plate against the steel front panel so that the plastic insert is held between the two plates. Install the  $\frac{3}{8}$ " nut on the volume control shaft and tighten it. Now install the two small brass self-tapping screws above and below the tuning shaft. Rotate the volume control shaft fully counter-clockwise and install the small knob with the pointer at the 7 o'clock position. Install the large knob on the tuning shaft, and tighten the set screws of both knobs.

Install the rubber feet in the corner holes of the bottom plate by inserting a #6 screw in the recess of each foot, and secure each with a nut on the inside of the bottom plate. Secure the bottom plate and cover with the four sheet metal screws. The flange on the front of the cover slides between the steel front panel and the aluminum front plate. Care should be exercised when handling the unit, for the gold anodized panel and knobs will not withstand undue abuse.

Now plug the Dynatuner in (to AC current sources only) and turn it on. Allow it to operate for an hour or more to allow the tubes to age and for operating conditions to stabilize before proceeding with alignment. During this time you should be able to enjoy reception from local stations.

### ALIGNING YOUR DYNATUNER

The Dynatuner is unique in its simplicity of alignment. Every stage can be aligned using the dual beam tuning eye as an indicating instrument, and this alignment is as precise as can be accomplished with the most complex laboratory equipment. The ability to achieve this measure of accuracy without external test equipment is a Dynatuner exclusive, and the indicating accuracy of the tuning eye circuit surpasses that of any comparable meter system.

It is important to emphasize that when this procedure has been carefully followed, it is not possible to "improve" on this alignment, and the Dynatuner will meet the most rigorous performance standards. *It is essential that any serviceman who works on this tuner be informed of this procedure, and that he is also advised that conventional "sweep" alignment techniques are not considered either satisfactory or desirable.*

It should be understood that successful alignment is dependent on a properly constructed tuner. A wiring error or a poor solder connection could prevent satisfactory completion of some steps, or could cause erroneous settings to the extent that additional test equipment might then be required to reestablish the proper operating conditions for realignment. Certain parts of the Dynatuner have been preset close to the proper operating point. These include the I.F. transformers, the discriminator transformer, the multiplex transformers, and the slug-tuned coils on the PC-7 board.

The cover and bottom plate must be removed for alignment. The complete stability of the Dynatuner allows precise alignment without special shielding. Before proceeding with alignment, three approximate adjustments should be made, which will permit reception of local stations during the hour of operation while tube conditions stabilize. A similar aging period should be allowed before realignment following any tube replacement on PC-7 and PC-8.

On top of the tuning capacitor C1 there are two adjustment screws (trimmer capacitors) accessible through the two holes in the top of the shield. The center screw (C1-D) adjusts the mixer, and the rear screw C1-B adjusts the R.F. stage. *The approximate settings given in steps #1 and #2 below have already been made as the capacitor is supplied to you.*

- 1 ( ) Turn in the screw C1-D on the center (mixer) section until it is in all the way. It should be snug, but do not force it. Then back it off  $\frac{1}{4}$  turn counter-clockwise.
- 2 ( ) Turn in the screw C1-B on the rear (R.F.) section until it is in fully, but do not force it. Then back it off  $\frac{1}{8}$  turn counter-clockwise.
- 3 ( ) The oscillator trimmer capacitor C8 screw (accessible from below the chassis) should be turned until the head of the screw is  $\frac{3}{16}$ " from the triangular nut.

With an antenna attached, and with the tuner connected to an amplifier and a speaker, turn the tuner on. The dial lamp should light, and there should be a slight glow visible in each tube, and then the tuning eye should glow. All of this should take only about 15 seconds. When turning the tuning knob, some deflection of the lower beam of the tuning eye should be apparent as the tuning passes the frequencies of local stations. At higher settings of the volume control, it should be possible to hear some hiss between stations and sound from the stronger stations. If all of these effects cannot be obtained, refer to the section "In Case of Difficulty" before attempting to use the tuner further or to align it.

Two tools are necessary for alignment: a small tipped screwdriver with an insulated handle, and a plastic tool (supplied) which has a hexagonal end for adjustment of the tuning slugs in the I.F., discriminator and multiplex transformers. *Only* the plastic tool should be used to adjust

these transformers. Any other type of instrument will damage the tuning slugs, requiring replacement of the transformer. When using the plastic tool, all adjustments are to be made using the end which has a shoulder to prevent inserting the tool too far.

**BE CAREFUL IN HANDLING THE CHASSIS DURING ALIGNMENT. THERE IS SOME SHOCK HAZARD BECAUSE OF THE EXPOSED WIRING.**

It is suggested that you read these instructions completely before proceeding, to familiarize yourself with the general procedure. The tuner is to be connected to an amplifier and speaker, turned on, and the antenna attached as for normal use.

The alignment of the FM-3 is carried out in two stages. First, the main tuner portion (PC-7 and PC-8) is aligned, and then the multiplex section. *Pull the volume control knob "OUT" to disable the multiplex circuit and eliminate its effects during alignment of the I.F. stages, discriminator, and the front end.* For these sections, the alignment instructions will refer to the lower (tuning eye) beam of V8, where Dyna's exclusive reference grid will simplify locating the precise peaks.

**Alignment of the I.F. Stages**

These adjustments require the insertion of the plastic alignment tool into the threaded slugs inside the aluminum I.F. transformers, and the rotation of these slugs until they are in a position, easily determined, which represents correct alignment. If the tuner has been built correctly, it will not be necessary to make more than a small adjustment to reach the right point. **IF A SLUG MUST BE TURNED MORE THAN ONE FULL TURN, YOU WILL PROBABLY BE COMPENSATING FOR SOME FAULT IN WIRING OR COMPONENTS, AND YOU SHOULD STOP TO CHECK BEFORE PROCEEDING FURTHER.**

The end of the alignment tool with the shoulder should always be used, with the tool inserted until the shoulder stops it. **IF THE CORE SLUG STOPS TURNING, DO NOT ATTEMPT TO FORCE IT BEYOND THIS POINT.** There are two slugs in each I.F. transformer, and it is possible, particularly if the slugs have been turned too much, for them to touch each other. If an attempt is made to turn them further, the slugs are likely to break, requiring replacement of the entire transformer.

Two points require special attention. *Never use any tool or instrument to turn the slugs except the alignment tool supplied or one exactly like it.* A conventional metal tool may break the slug. When working from the underside of the chassis with the tuner on, *you must constantly bear in mind the hazard of possible shock from exposed wiring.* If you wish, the bottom plate can be installed during alignment of the I.F. stages.

- 4 ( ) Turn the tuning knob until you find a place where no station can be heard (only hissing). Insert the end of the plastic alignment tool into the top of I.F. transformer T4, and slowly rotate the slug until the hissing is loudest.

As this and the following steps proceed, the hissing will become louder, and the loudness peak will become sharper and easier to locate. If the hiss becomes annoyingly loud, adjust the level with the volume control; the lower half of the eye tube V8 will usually begin to close as the noise increases after the first step or two, and this should be used, rather than the sound, for the remainder of the adjustments.

If it is difficult to make the adjustment because of lack of hiss, use a station to make this series of adjustments. *Then repeat the procedure while tuned between stations,* using hiss as an audible signal until there is sufficient deflection of the tuning eye lower bar to use this as an indication. Always follow the sequence described.

- 5 ( ) Adjust the bottom slug of T4.
- 6 ( ) Adjust the top slug of T3.
- 7 ( ) Adjust the bottom slug of T3.
- 8 ( ) Adjust the top slug of T2.
- 9 ( ) Adjust the bottom slug of T2.
- 10 ( ) Adjust the top slug of T1.
- 11 ( ) Adjust the bottom slug of T1.

**Alignment of the Discriminator**

The alignment of the discriminator determines the distortion and noise rejection of the tuner, and is therefore a critical adjustment. The Dynatuner provides a positive method of adjusting the discriminator to exactly the right point.

- 12 ( ) Tune a station which gives a good clean mono signal clearly indicated by a definite tuning peak. Ideally, it should not be a very weak or a very powerful signal, and it should be separated from adjacent channel stations by normal interstation hiss as you tune through it. These precautions will insure against imperfect alignment through using an atypical signal. *The accuracy of alignment depends on the correctness of this tuning. Be sure that you do not disturb the tuned setting during the following steps.* While they are being performed the tuning eye will be used to show other effects.

- 13 ( ) Unscrew (counter-clockwise) the top slug of the discriminator transformer T5, using the shoulder end of the plastic alignment tool, until the top of the slug is flush with the top of the transformer. This detunes the secondary winding of the discriminator transformer, essential in order to obtain the optimum adjustment of the primary winding, done in the next few steps. The tuning eye is used as an indicator for this adjustment, by connecting it to another part of the circuit than that to which it is now connected.

*If you are very careful,* it is possible to do the necessary unsoldering and resoldering of connections without turning off the tuner. However, **YOU MUST BEAR IN MIND THE HAZARD OF POSSIBLE SHOCK FROM EXPOSED WIRING.** Care and deliberation can eliminate this hazard, but, if you wish to avoid all risk of shock, turn the tuner off before making the new connections, and turn it on again to make the adjustments. If you do this, it is *essential* that you allow the tuner to warm up for a few minutes each time before making an adjustment, even if it has been off for less than a minute.

NOTE: If a VTVM is available, discriminator alignment can be considerably simplified by skipping immediately to step 24 below. The VTVM should be of a type which has at least a 1 megohm resistor in the DC probe to isolate the probe and lead capacity from the measured circuit.

- 14( ) Unsolder and lift off the jumper wire which connects from eyelet #23 on PC-8 to eyelet B.
- 15( ) Temporarily solder a wire from eyelet #23 to eyelet #32 on PC-8.
- 16( ) Adjust the *bottom* slug of T5 for maximum closing of the eye.
- 17( ) Unsolder the end of the temporary wire from eyelet #32 and temporarily connect it to eyelet #31.
- 18( ) Solder a 2" piece of bare wire to the center ground pin of socket V7.
- 19( ) Turn the *top* slug of T5 in (clockwise) 9 full turns, which brings it close to the proper adjustment point.
- 20( ) Touch the free end of the wire from the center ground pin of V7 to eyelet #31. You will observe that there is a deflection of the eye (either inward or outward). Rotate the *top* slug of the discriminator transformer T5 back and forth slowly while *alternately touching and releasing* the free end of the wire from the center ground pin of V7 to eyelet #31. The actual adjustment of the slug must be made while the wire is *not* touching the eyelet. Check the eye's deflection *after* each change. You are seeking the precise point where there is *no shift in the tuning eye* as the wire is touched to, and removed from, eyelet #31. There may be slight changes in the brightness of the eye as this is done, but these are of no consequence. Turn the slug in the direction which minimizes the shift in deflection until there is no shift when the wire makes or breaks contact with eyelet #31.
- 21( ) Remove the temporary wire between eyelets #23 and #31.
- 22( ) Re-connect the jumper wire from eyelet #23 to eyelet B. Keep it reasonably close to the board.
- 23( ) Remove the wire from the center ground pin of socket V7.
- 24( ) THIS STEP REPLACES STEPS 14 THROUGH 23 WHEN A VTVM IS USED FOR DISCRIMINATOR ALIGNMENT. IF YOU ARE NOT USING A VTVM AND HAVE COMPLETED STEPS 14 THROUGH 23, PASS TO STEP 25 NOW.

Switch the VTVM to -DC and set it for a range of about 10 volts full scale. Connect the COMMON lead to the tuner chassis, and the DC probe to eyelet #32. Adjust the *bottom* slug of T5 for the maximum meter reading (about -8 volts).

Switch the VTVM to its most sensitive scale. While shorting its leads together, reset its zero adjustment to bring the meter needle to a specific point near mid-scale which can serve as a new zero, or to a center-scale zero if one has been printed on your meter scale. Connect the COMMON lead to the chassis again, but connect the DC probe to eyelet #31 this time. Turn the *top* slug of T5 in (clockwise) 9 full turns as a first approximation, and then carefully adjust it until the meter reads exactly zero. To do this correctly, it is essential that you go *through* zero first, and then back up to locate it precisely.

- 25( ) Cut a one inch piece of wire and strip  $\frac{1}{4}$ " of insulation from one end. The other end need not be stripped. Insert the stripped end into the bottom of eyelet #29 (S). This wire should stand up straight from the PC-8 board with the other end free, and adjacent wires should be positioned away from it. This wire should be cut off so that it stands upright to a height of  $\frac{1}{16}$ " above the PC-8 board. This wire may seem to be unusual, as it is connected at one end only. However, it is what is known in electronic parlance as a "gimmick" and it is actually a small value capacitor which corrects for the effects of interaction between the adjustments of the two slugs in the discriminator transformer. *At such times as realignment is performed, this "gimmick" should be removed before aligning the discriminator.*

#### Alignment of the Front End

If you wish, the bottom plate can be installed during alignment of the front end. In this section, dial tracking will be simplified if another FM radio is available to enable you to identify stations readily. Make sure capacitor C9 is vertical, for if it is tilted toward C8, dial tracking will be affected.

- 26( ) Turn the tuning knob until you have located an FM station of known frequency at the high end of the band (close to 108 megacycles), the higher the better.
- 27( ) Adjust the oscillator trimmer capacitor C8 using a small screwdriver. At the same time readjust the tuning knob until the station's frequency is indicated in the plastic window by the tuning dial. In other words, you set the dial to show the correct frequency and adjust the trimmer capacitor until the eye closes to a maximum.
- 28( ) Now find a station of known frequency at the lowest end of the dial (close to 88 megacycles). Using a small screwdriver, and *touching only the insulated handle*, adjust the brass slug in the oscillator coil L4 while setting the tuning dial to the station's broadcast frequency. This is the same type of adjustment as was made in the preceding step.

It may be necessary to repeat the adjustments at the two extremes of the dial several times to have the tuner "track" properly. If the adjustments are not made accurately, the dial readings will not coincide with station frequencies across the dial. Correctly following this procedure should enable dial tracking which is accurate to within  $\frac{1}{8}$  division ( $\pm 0.2$  megacycles).

- 29( ) Tune accurately to a station near 108 megacycles and adjust the two trimmer capacitors C1-B and C1-D on the top of the tuning capacitor. *The screwdriver should not touch the capacitor shield when making these adjustments.* The adjustment should be made for maximum eye closing. If the eye is closed to its normal maximum, the effects of these adjustments will not be readily apparent, so it is *essential* that a *weak signal* be used here (where the eye is about  $\frac{1}{4}$ " open) or proper alignment will not be realized.



To obtain a sufficiently weak signal, it may be necessary to remove the antenna and substitute a short piece of wire. Shorting out half the antenna is another alternative. With signals of this magnitude (a very few microvolts) it will be noticed that the eye is sensitive to flutter as a result of airplanes passing overhead, or varying signal strength as a result of atmospheric conditions. Care must be taken not to allow this sensitivity to influence the actual adjustment of C1-B and C1-D.

- 30( ) Tune carefully to a station near 88 megacycles and adjust the two brass slugs in the mixer coil L3 and the R.F. coil L1 for maximum eye closing.

The last two adjustments should be repeated, since there is interaction between adjustment of the trimmer capacitors and the slugs of the coils. This adjustment of L1 and L3 is not critical, and may be a broad peak, necessitating an approximate center setting, but the accuracy of adjustment of C1-B and C1-D has a very definite correlation with the tuner's effective sensitivity, so that extra care here will be well repaid in superior performance.

### Alignment of the Multiplex Integrator

The basic Dynatuner alignment in the preceding sections should be carried out before aligning the multiplex integrator. In particular, *the discriminator must be accurately aligned* if maximum noise rejection is to be realized, and this becomes doubly important in stereo operation, for the effective sensitivity and noise rejection of any tuner is lower in stereo than in the mono mode.

The tuner must have an antenna connected, but it is not necessary for an amplifier and speaker to be connected for this part of the alignment. *Tune precisely to a known stereo broadcast*, for this part of the alignment involves tuning the multiplex transformers to the 19KC pilot signal which is an integral part of every stereo broadcast. You can enjoy normal monophonic reception prior to alignment of the multiplex integrator, since its adjustments affect only the separation of stereo programs.

*Push the volume control "IN"* so that it is in the normal STEREO MATIC operating position. The upper beam of V8 is the STEREOCATOR. After alignment, it will be either fully open or fully closed whenever you are tuned to a station, and thus will illuminate or turn off the word STEREO printed on the plastic insert in the front panel. Between stations the ambient noise may cause it to flicker, but this is of no consequence.

You will be able to see the STEREOCATOR quite well during alignment if you look down on V8 from above, but if you wish to observe its operation more easily, remove the knobs, front plate and plastic insert.

- 31( ) Temporarily connect one end of the 1.2 megohm (brown-red-green) resistor R94 to the center ground pin of V71 (S). Temporarily connect the other end to eyelet #75 (S). Eyelet #75 is one test point, and is marked with the letters TP on the bottom of the board. Using the shoulder end of the alignment tool, adjust transformer T71 for maximum closing of the STEREOCATOR. Then adjust transformer T72 for maximum closing of the STEREOCATOR. Repeat these adjustments, first with T71 and then with T72, until the beam closes no further. Usually only a small adjustment will be necessary.

- 32( ) Unsolder the end of the 1.2 megohm resistor soldered to eyelet #75, and temporarily solder it to eyelet #88. This is the other test point TP.
- 33( ) Unsolder the green wire connected to eyelet #75 and temporarily connect it to eyelet #88 (S).
- 34( ) Adjust the *top* slug of transformer T73 for maximum closing of the STEREOCATOR. Then adjust the *bottom* slug of T73 for maximum closing of the STEREOCATOR. Repeat these adjustments, first with the top, and then the bottom slug, until the beam closes no further.
- 35( ) Unsolder the 1.2 megohm resistor from the V71 ground pin and eyelet #88. It can be saved for future use when realignment is desired.
- 36( ) Unsolder the green wire from eyelet #88 and reconnect it to eyelet #75 (S).

This completes the alignment of your Dynatuner. No further alignment should be required unless there is a change in tubes or components. When necessary, you have the means of realigning it so that your Dynatuner will always be at the very peak of its performance capabilities. However, one word of caution is in order—do not make these adjustments unnecessarily, as the various slugs will eventually loosen and cause tuning shifts to the detriment of performance. Alignment adjustments should be considered as a semi-permanent type of adjustment.

Reassemble the tuner, making sure the cover front flange slips between the aluminum front plate and the steel panel. Your STEREO MATIC Dynatuner is now ready for long pleasurable use.

### SPECIAL INSTRUCTIONS FOR OPTIONAL 120-240 VOLT POWER TRANSFORMERS

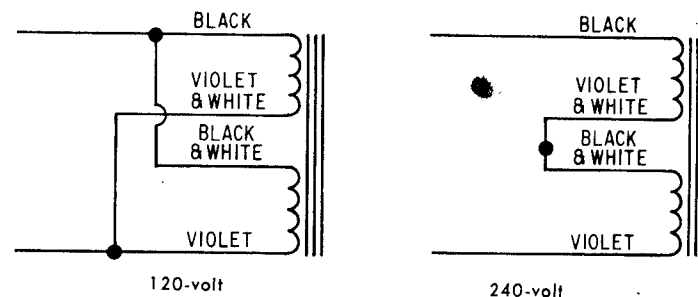

Dynatuners supplied with optional power transformer PB-012 can be wired for use with either 120 or 240 volt, 50 or 60 cycle AC power sources, as follows:

#### For 120 Volt Operation

- 1( ) Twist together the black and black-white power transformer leads. Connect both leads to lug #2 of the AC outlet.
- 2( ) Twist together the violet and violet-white power transformer leads. Connect both leads to lug #2 of the fuse holder (S-2).

#### For 240 Volt Operation

- 1( ) Twist together the black and the violet power transformer leads. Connect the black lead to lug #2 of

the AC outlet. Connect the violet lead to lug #2 of the fuse holder (S).

- 2( ) Twist together the black-white and the violet-white power transformer leads. Connect both leads to lug #1 of the five lug terminal strip (S-2).

When using the 240 volt connection, a one-half ampere slo-blo fuse should be used instead of the one ampere fuse recommended for 120 volt operation.

### IN CASE OF DIFFICULTY

In the event that your first attempt at listening to your Dynatuner is unsuccessful, a systematic approach to locating the difficulty will save you much time and trouble.

Because 90% of the difficulties which are encountered can be attributed to either incorrect wiring or to a poor solder connection, it is strongly recommended that you first ask someone else to check the wiring against the pictorial diagrams, as frequently one person will make the same error twice.

In the course of trouble shooting, inspect very carefully for "bridges" of solder from one point to another. Also recheck for correctness of component positions on the etched circuit boards. Many defects of this type, as well as faulty components, can be ascertained by voltage measurements, and a complete voltage chart is provided. Any deviation of 20% or more from this chart (except for voltages marked <sup>3</sup>) indicates a possible error or component failure. Examination of components in the area of incorrect voltage (with reference to the schematic diagram) should help to uncover the difficulty.

For purposes of simplification, the initial trouble-shooting suggestions will be confined to the basic tuner circuit, for the Multiplex Integrator does not usually affect mono reception. The volume control knob should be pulled "OUT" for this part.

Normal radio servicing techniques of signal injection and signal tracing are appropriate for localizing troubles. For best alignment, however, the procedure specified in these instructions should be followed. If servicing is done by a qualified technician, he can expedite alignment by setting the I.F. transformers for peak eye deflection using a *very low level* 10.7 mc signal. The strength of this signal should be just strong enough to actuate the tuning eye, but not so strong that it closes it to its normal minimum gap. As the alignment proceeds, it will be necessary to reduce the level of this test signal so that the tuning eye accurately indicates the alignment peaks. Discriminator alignment *must* follow the technique described in these instructions. *Conventional "sweep" techniques should not be used.*

Drift, or shifting of the tuned signal frequency, should be cause to suspect poor mounting or soldering of C7 or C8, or a defective 6AT8A tube.

If the dial lamp and tubes do not light when the set is plugged in and turned on, check to see if the fuse is all right. Sometimes a fuse may appear to be intact, but the circuit will be open at one end. A continuity test at the prongs of the line cord with a meter will show if the fuse, power switch, and the power transformer primary winding are all properly connected and functioning.

If the one ampere fuse blows when the set is turned on, remove all the tubes, install another one ampere slo-blo fuse and try again. If the same size replacement fuse blows

when all of the tubes are removed, the trouble lies either in the line cord, the power transformer, or in heater connections in the tuner. Check particularly those wires connected to the 5 lug terminal strip.

If the tubes light, but not the dial lamp, the lamp may be defective, or the wires which lead to it via the etched circuit board may be open.

If the tubes light and the tuning eye tube shows a lighted filament, but the eye does not have a blue-green glow on the front screen (which is visible through the plastic insert in the front panel) check the wiring around the tuning eye socket. If this is all right, the fault may be in the power supply, and the rectifier tube V9 and the associated wiring should be checked. If the eye glows, the power supply wiring can be assumed to be correct.

If the tuning eye does not deflect when the tuning knob is turned, the difficulty is probably on PC-7. Check the 6AT8A tube and also wiggle the antenna coil L1 to make sure its solder connections are firm.

Frequently difficulties in the I.F. strip (PC-8) can be localized by touching the #1 pin of each I.F. tube in the sequence V6, V5, V4, V3. A noise should be heard each time the #1 pin is touched, and the tuning eye should deflect. If you find a #1 pin which does not produce a noise, then look for the difficulty between that point and the previously tested #1 pin.

If there is apparent distortion in the signal, make sure that this is not a momentary effect because of poor transmission. See if the same distortion is apparent on another station. If it persists, compare the same system with phonograph or tape as a different program source to see if the effect can be localized to the tuner. If it is definitely in the tuner, it may be caused by improper discriminator alignment, and this portion of the alignment procedure should be repeated. Audio distortion is also an effect of "multipath dispersion"—reflections of the signal by buildings, hilly terrain, etc., which cause effects similar to television "ghosts", often accompanied by reduced separation on stereo broadcasts. Multipath effects can be reduced only by improving the antenna system—relocation, reorientation, or replacement with a more directional antenna.

If the tuner operates and can be aligned, but has hum in the signal, there are several tests to be made. If the hum is part of the signal and disappears when the volume is turned down, try several stations, as it is possible that the one used as a test signal is broadcasting some hum. If hum occurs on all stations, the 6AT8A may be faulty and should be checked (preferably by substitution). If the hum persists, even when the volume control is turned down, unplug the tuner from the associated equipment and see if the hum disappears. If it does not, the fault lies in the associated equipment. If it does disappear, then the hum may be caused by a defective ground contact in one of the audio cables, or it may be associated with V7 or V72. Check the 12AX7s by substitution.

If the eye deflects as the tuning dial is turned, this is an indication that the R.F. stages and the I.F. stages are working, and the difficulty lies either in the discriminator transformer or the subsequent audio stages. Working backwards from the audio outputs, touch the following points with a screwdriver to see if you get a pop or hum through the speaker when the tuner volume control is turned up: The center conductor of each output socket, pin #2 and pin #7 of V72, eyelet 71, pin #2 and pin #7 of V7. If a noise is not heard through the speaker when one of these points is

## FACTORY SERVICE AND WARRANTY

touched, the circuitry immediately following it should be carefully checked. For these tests the volume control knob should be pushed "IN" so that the left and right channels will be independent on stereo programs.

In most cases, if the V8 socket has been correctly wired, improper indication by the STEREOCATOR is an effect rather than a cause. If the STEREOCATOR indicates STEREO on both mono and stereo stations, the 19KC amplifier is oscillating. A rough check of the STEREOCATOR is to disconnect the green wire from eyelet #75 and touch the free end with the finger, which should illuminate the word STEREO.

If the STEREOCATOR passes this test, but does not deflect on a known stereo broadcast, check the 6BL8, and also check the continuity of T71 and T72 with an ohmmeter. The resistance of each transformer pin to ground is approximately as follows: #1 pin-0 $\Omega$ , #2 pin-40 $\Omega$ , #3 pin-10 $\Omega$ , #4 pin-100 $\Omega$ . The #1 pin is identified on the board by a white mark (the indicator on the top of the transformer) and the pins are numbered *clockwise* when looking at the *bottom* of the board.

If the STEREOCATOR aligns normally but does not close completely on every stereo broadcast, this should be regarded as a transmission deficiency if other stereo broadcasts cause the STEREOCATOR to overlap normally.

If the STEREOCATOR is operating correctly, but there is little or no separation on a known stereo broadcast, make certain that the fault does not lie in the broadcast. Program material or transmission deficiencies are common causes of such complaints where stereo programming is relatively new. If it has been determined that poor separation is a fault of the tuner, and the STEREOCATOR operates normally, the fault may lie in a weak 6BL8, or in incorrectly aligned transformers T71, T72 or T73. Incorrect alignment can also cause channel reversal. Normally, the A output jack (the one nearest the line cord) is the left channel. The 6BL8 should be checked by substitution. An approximate mechanical positioning of the transformer slugs may facilitate realignment by the procedure described earlier in the manual. T71 and T72 should be set 2 to 5 turns counter-clockwise from the stop at the bottom of the transformer; the bottom slug of T73 should be set 2 turns clockwise (when viewed from the bottom) from the stop at the bottom of the transformer; and the top slug of T73 will usually reach its peak 6 to 8 turns clockwise from the top of the transformer. A false peak a few turns from the top may be noticed on the top slug of T73. The correct peak, however, will always produce a greater closure of the STEREOCATOR. Now proceed with normal alignment.

A diode which is faulty, or one which is installed incorrectly may also reduce the separation, but this will usually be accompanied by a significant reduction in output on the affected channel.

If the 6BL8 tube is removed, there will be no separation, and the STEREOCATOR will not light, but monophonic transmissions will still be received normally with equal output from the A and B output jacks. If these signals are unbalanced, or if one channel is distorted, the difficulty is in the diode bridge or in the V72 circuit.

Once aligned, the separation capabilities of the tuner do not vary, but are determined by program variations. In isolated instances, a program which does not fully conform to established broadcast standards may be received with below normal separation.

The Dynatuner is designed to provide reliable, trouble-free performance for a long period of time, when properly assembled and installed. It is intended for use with the 120-volt AC power supplied to most homes. Although variations of several volts above or below this figure will have no pronounced effect upon performance or component life, the normal guarantee on the equipment is not applicable if it is operated with AC inputs greater than 130 volts. If your local power is this high or higher in voltage, it is suggested that a voltage regulating or adjusting device be installed to protect the tuner.

All parts used in the Dynatuner are guaranteed for a period of one year from the date of purchase except tubes, which carry the standard electronic industry (EIA) 90-day warranty. Defective parts will be replaced at no charge if they are returned prepaid to the factory either directly or via the dealer from whom the kit was purchased. After the guarantee period has passed, DYNACO, Inc. will supply any non-standard parts used at net prices. Parts which are standard (resistors, capacitors, tubes) can generally be purchased from a local electronics supply store.

If the PA-509 transformer is returned for factory repair or exchange, it should be removed from the tuner without cutting the leads short. *If leads have been cut rather than unsoldered, so that they are no longer usable, the guarantee on the transformer is voided.*

In the event that the assembled tuner does not function properly or breaks down after some use, Dyna Company will service the tuner for a fixed service fee plus the cost of parts which have been damaged by the user or are past the guarantee period. The service fee is \$12.50 and includes necessary repairs, checkout, and alignment. If only checkout and alignment are required, the service fee is \$5.00.

Factory assembled Dynatuners include a one-year warranty on labor as well as parts.

Fixed-charge service and maintenance are not available for kits which are incompletely wired or kits wired with solder other than rosin core type, or kits physically or electrically modified without prior factory authorization. The serial number on the front cover of this instruction book must be mentioned in all correspondence and in any case where parts are returned, or kits sent or brought to the factory for service. Returns do not require prior factory authorization.

It is the factory prerogative to limit the service facility to one year from the date of purchase.

When shipping the tuner to DYNACO, Inc., for service, attach a note specifying the symptoms, the name and address of the sender, and the serial number of the kit. The kit should be securely packed to withstand the abuses of handling in transit. The front plate should be protected with a plastic or wax paper covering, or it may be removed. The unit should be placed in a rugged carton surrounded by several inches of shredded paper or other soft packing material. The original carton in which the tuner is supplied is suitable for shipping if the original inserts are properly used.

Shipment should be made by prepaid EXPRESS, where possible; repaired kits will then be returned EXPRESS C.O.D. for freight and service charges (unless these charges have been prepaid). PARCEL POST IS NOT A SAFE METHOD FOR THE SHIPMENT OF ASSEMBLED KITS, AND SHOULD NOT BE USED FOR THIS PURPOSE.

The DYNA Company assumes no liability or responsibility for damages or injuries sustained in assembly or operation of the Dynakit.

## VOLTAGE CHECK POINTS

All voltages are measured with the volume control at *minimum*. Unless otherwise indicated, all voltages are measured between the point indicated and the chassis, *using a vacuum tube voltmeter*. Many of the voltages will vary widely under different signal conditions. **NO SIGNAL** indicates that the dial is tuned between stations. **QUIESCENT** voltages are measured with V6 removed from its socket. **STEREO** voltages are measured when tuned to a station *known* to be transmitting a stereo signal.

	TUBE	CONDITION	PIN #								
			1	2	3	4	5	6	7	8	9
V 1	6AQ8/ECC85	NO SIGNAL	145 DC	0	.8 DC	6.3 AC	0	145 DC	0	.8 DC	0
V 2	6AT8A	NO SIGNAL	-3 DC <sup>1*</sup>	52 DC	2 DC	0	6.3 AC	220 DC	52 DC	0	0
V 3	6BA6	NO SIGNAL	-.2 DC <sup>1</sup>	0	0	6.3 AC	85 DC	85 DC	.4 DC		
V 4	6BA6	NO SIGNAL	-.2 DC <sup>1</sup>	0	0	6.3 AC	82 DC	82 DC	0		
V 5	6AU6/EF94	NO SIGNAL	-.45 DC <sup>1</sup>	0	0	6.3 AC	10 DC	44 DC	0		
V 6	6AU6/EF94	NO SIGNAL	-2 DC <sup>1</sup>	0	0	6.3 AC	42 DC	85 DC	0		
V 7	12AX7/ECC83	NO SIGNAL	215 DC	-1.5 DC <sup>2</sup>	17.5 DC	6.3 AC	6.3 AC	125 DC	0	.9 DC	0
V 8	EMM801	QUIESCENT	0	205 DC	0	0	6.3 AC	29 DC	-.64 DC	53 DC	-.6 DC
		STEREO	0	200 DC	0	0	6.3 AC	180 DC	-14 DC <sup>3</sup>	150 DC	-7 DC <sup>3</sup>
V 9	6V4/EZ80	ANY	255 AC	0	285 DC	6.3 AC	0	0	255 AC	0	0
V 71	6BL8/ECF80	QUIESCENT	29 DC	0	78 DC	6.3 AC	0	72 DC	1 DC	1.5 DC	-.15 DC
		STEREO	45 DC	0	71 DC	6.3 AC	0	64 DC	1.1 DC	1.1 DC	-14 DC <sup>3</sup>
V 72	12AX7/ECC83	ANY	135 DC	0	.85 DC	0	0	135 DC	0	.85 DC	6.3 AC

\* This voltage will indicate whether or not the local oscillator is functioning and should not vary by more than one volt over the entire tuning range when the oscillator is properly adjusted for the FM band. In measuring this voltage, the common lead of the VTVM must go to the cathode (pin #3).

<sup>1</sup> Use a 100,000  $\Omega$  resistor in series with the probe when measuring these voltages.

<sup>2</sup> This voltage must be measured with the VTVM common lead connected to pin #3.

<sup>3</sup> These voltages vary with signal strength, but will always be negative.

Quadruple section filter capacitor lugs:

#1 285 DC

#2 255 DC

#3 225 DC

#4 220 DC

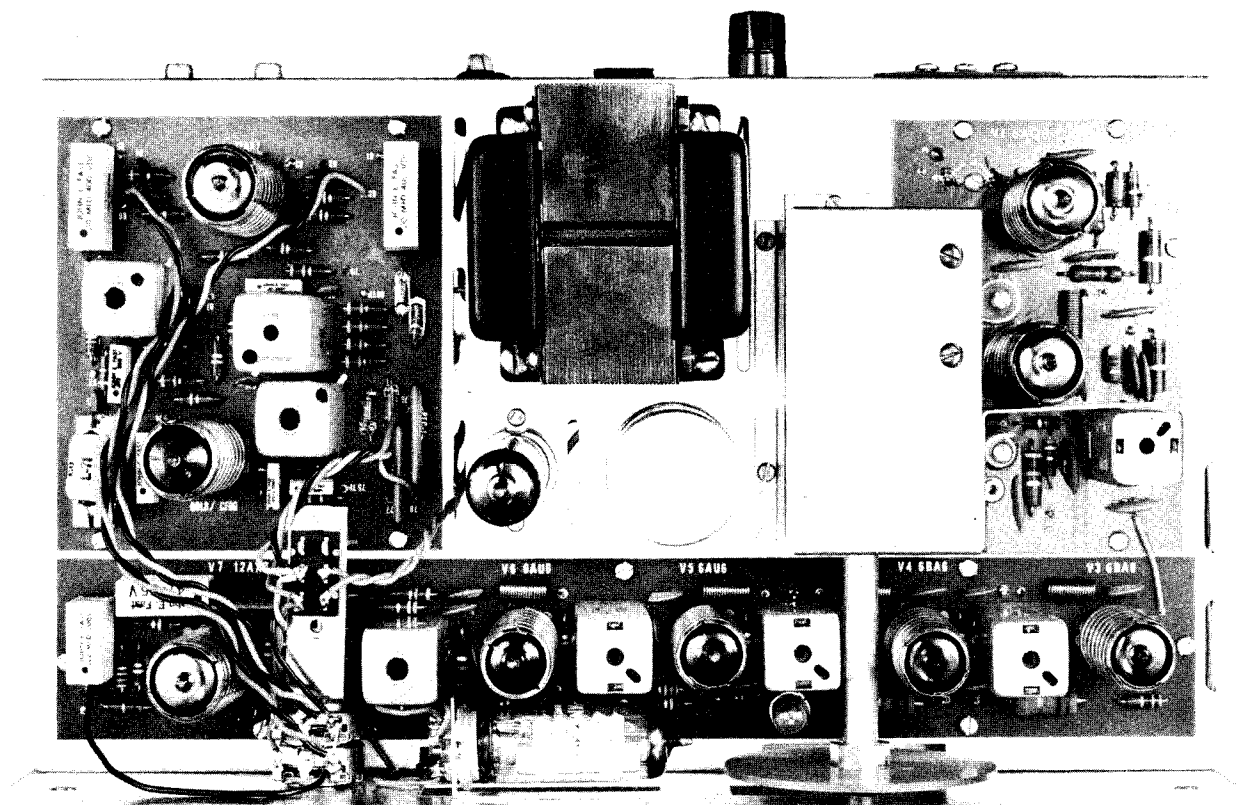

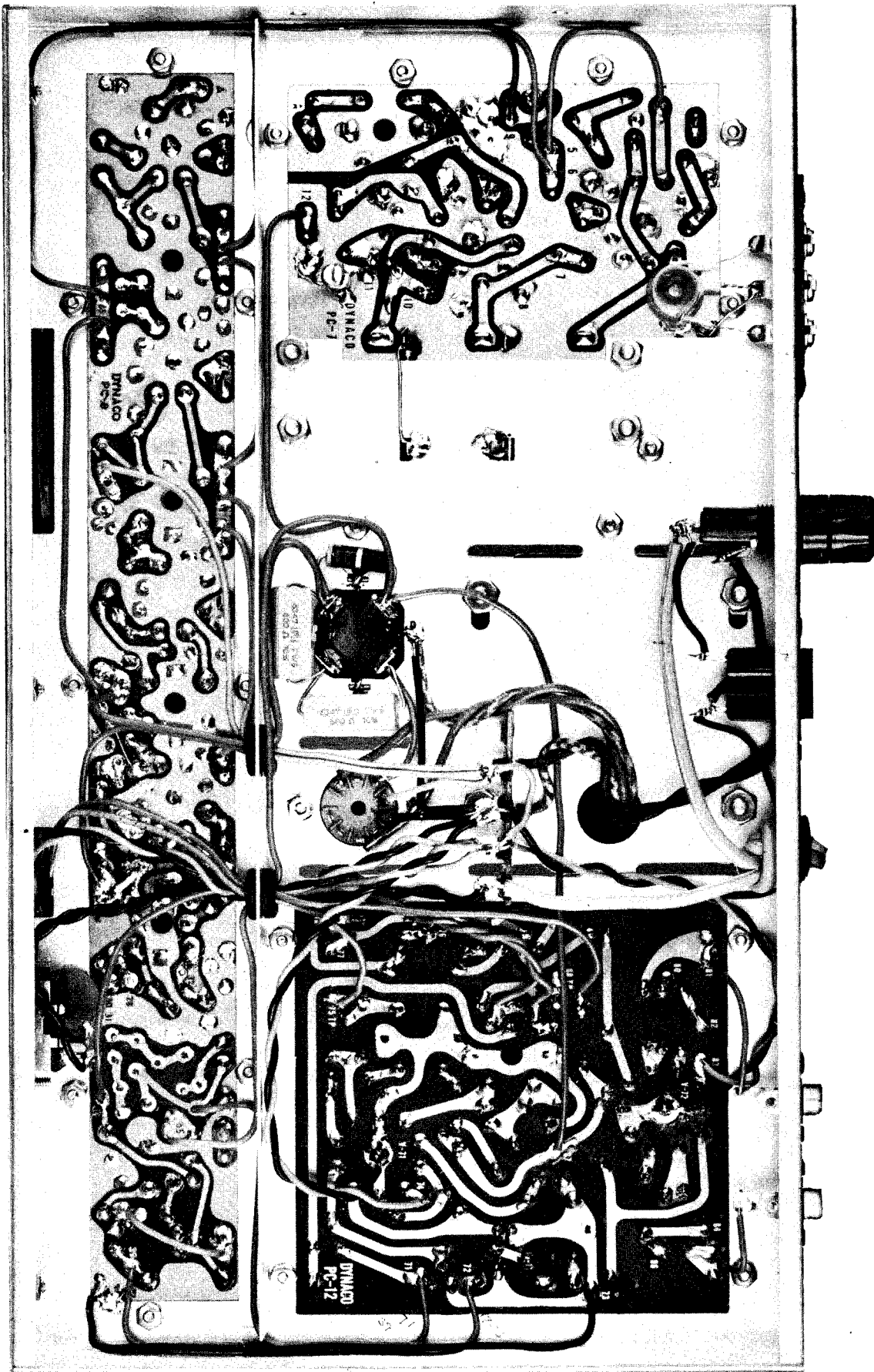

**PARTS LIST FOR SCHEMATIC DIAGRAM**

All resistors are 1/2 watt 10% unless otherwise noted.

- R 1 68 ohms
- R 2 10,000 ohms  
1 watt 5%
- R 3 10,000 ohms  
1 watt 5%
- R 4 390 ohms
- R 5 10,000 ohms  
1 watt
- R 6 47,000 ohms  
1 watt
- R 7 1,000 ohms  
1 watt
- R 8 1,000 ohms  
1 watt
- R 9 100,000 ohms
- R 10 33 ohms
- R 11 10,000 ohms  
2 watt
- R 12 100,000 ohms
- R 13 10,000 ohms  
2 watt
- R 14 100,000 ohms
- R 15 330,000 ohms
- R 16 220,000 ohms
- R 17 62,000 ohms
- R 18 100,000 ohms
- R 19 3.3 megohms

- R 20 100,000 ohms
- R 21 100,000 ohms
- R 22 47,000 ohms 1 w.
- R 23 47,000 ohms
- R 24 3,900 ohms
- R 25 62,000 ohms 5%
- R 26 62,000 ohms 5%
- R 27 1.2 megohms
- R 28 390 ohms
- R 29 8,200 ohms
- R 30 18,000 ohms
- R 31 100,000 ohms
- R 32 100,000 ohms
- R 33 330,000 ohms
- R 34 1,000 ohms
- R 36 500 ohm  
5 watt wirewound

- R 37 500 ohm  
5 watt wirewound
- R 38 470 ohm 1 watt
- R 71 18,000 ohms
- R 72 240 ohms
- R 73 22,000 ohms
- R 74 47,000 ohms
- R 75 150,000 ohms
- R 76 1.2 megohms
- R 77 3.3 megohms
- R 78 2,200 ohms
- R 79 220,000 ohms
- R 80 150,000 ohms
- R 81 47,000 ohms
- R 82 47,000 ohms
- R 83 47,000 ohms

- R 84 47,000 ohms
- R 85 100,000 ohms
- R 86 100,000 ohms
- R 87 1,000 ohms
- R 88 1,000 ohms
- R 89 100,000 ohms
- R 90 100,000 ohms
- R 91 470,000 ohms
- R 92 470,000 ohms
- R 93 470,000 ohms
- R 94 1.2 megohms
- C 1 ganged tuning capacitor
- C 2 180 mmfd
- C 3 180 mmfd
- C 4 47 mmfd NPO

- C 5 .0047 mfd
- C 6 10 mmfd NPO
- C 7 2.55 mmfd N2200
- C 8 ceramic trimmer
- C 9 .0047 mfd
- C 10 .0047 mfd
- C 11 2.2 mmfd
- C 12 47 mmfd
- C 13 180 mmfd
- C 14 .0047 mfd
- C 15 47 mmfd NPO
- C 16 .0047 mfd
- C 17 47 mmfd NPO
- C 18 .0047 mfd
- C 19 .0047 mfd
- C 20 47 mmfd NPO
- C 21 .01 mfd

- C 22 .0047 mfd
- C 23 .0047 mfd
- C 24 47 mmfd
- C 25 47 mmfd
- C 26 .01 mfd
- C 27 .0047 mfd
- C 28 .0047 mfd
- C 29 47 mmfd
- C 30 27 mmfd
- C 31 22 mmfd
- C 32 40/50 @ 3
- C 33 .02 mfd
- C 34 .0047 mfd
- C 35 .0047 mfd
- C 36 .0047 mfd
- C 37 .0047 mfd

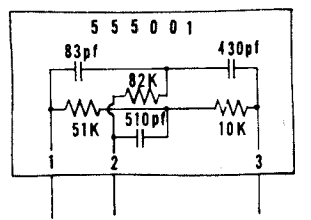
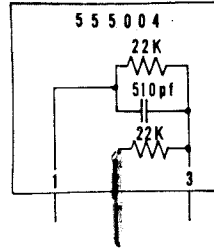
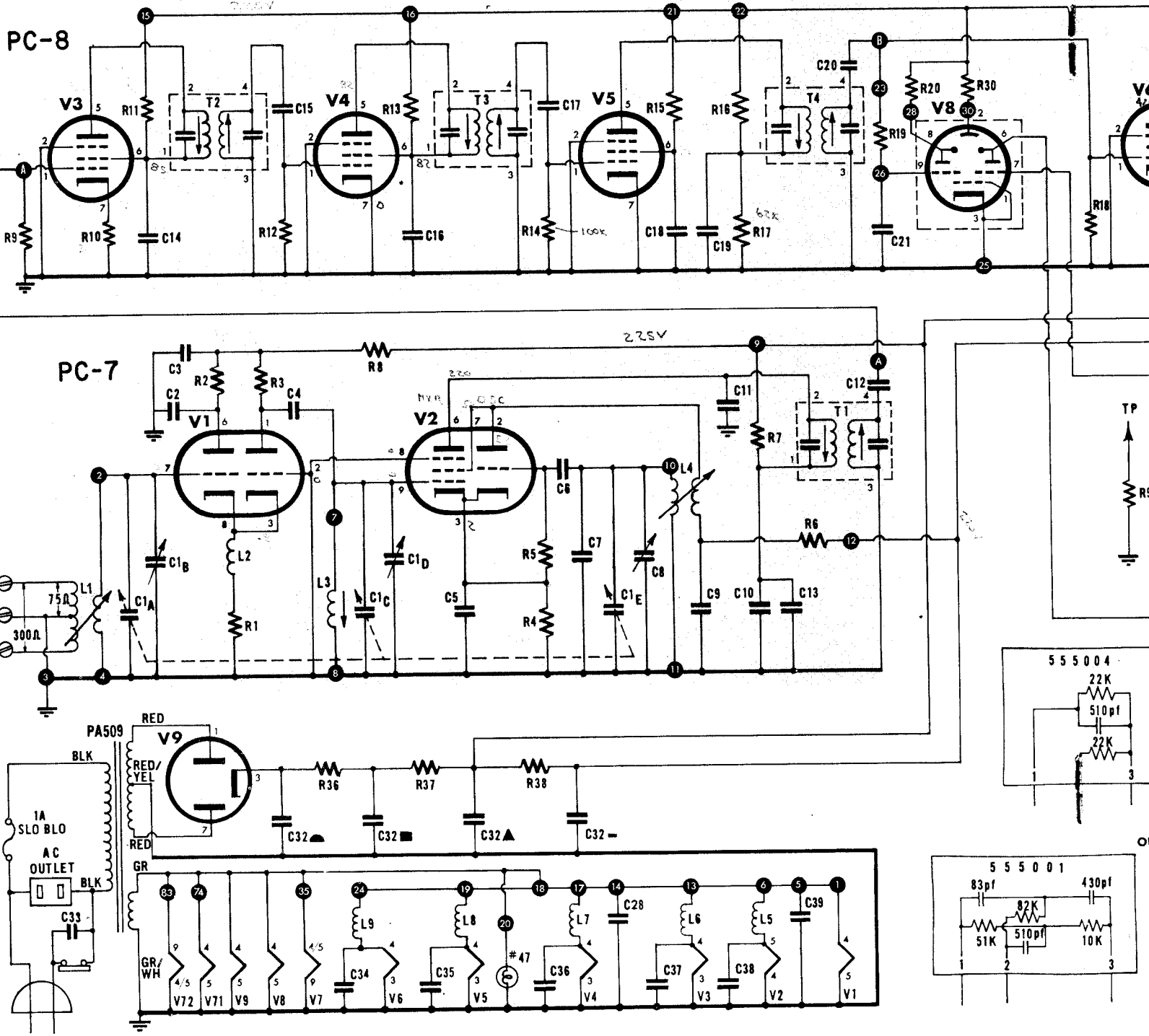

- C 22 .0047 mfd
- C 23 .0047 mfd
- C 24 47 mmfd NPO
- C 25 47 mmfd NPO
- C 26 .01 mfd
- C 27 .0047 mfd
- C 28 .0047 mfd
- C 29 .47 mfd
- C 30 27 mmfd
- C 31 .22 mfd @ 200 v.
- C 32 40/40/20/20 mfd @ 350 v.
- C 33 .02 mfd
- C 34 .0047 mfd
- C 35 .0047 mfd
- C 36 .0047 mfd
- C 37 .0047 mfd

- C 38 180 mmfd
- C 39 180 mmfd
- C 71 500 mmfd
- C 72 220 mmfd
- C 73 .012 mfd
- C 74 .0068 mfd
- C 75 500 mmfd
- C 76 .001 mfd
- C 77 .0033 mfd
- C 78 .0015 mfd
- C 79 .01 mfd
- C 80 500 mmfd
- C 81 100 mmfd
- C 82 .1 mfd
- C 83 .1 mfd
- C 84 18 mmfd

- D 71 1N541
- D 72 1N541
- D 73 1N541
- D 74 1N541
- L 1 antenna coil
- L 2 3.9  $\mu$ h choke
- L 3 mixer coil
- L 4 oscillator coil
- L 5 heater choke
- L 6 heater choke
- L 7 heater choke
- L 8 heater choke
- L 9 heater choke
- L71 53 mh choke
- T 1 I.F. transformer 432001

- T 2 I.F. transformer 432001
- T 3 I.F. transformer 432001
- T 4 I.F. transformer 432001
- T 5 Discriminator transformer 432002
- T 71 19 K.C. transformer 432003
- T 72 19 K.C. transformer 432003
- T 73 38 K.C. transformer 432004
- V 1 6AQ8/ECC85

- V 2 6AT8A
- V 3 6BA6
- V 4 6BA6
- V 5 6AU6/EF94
- V 6 6AU6/EF94
- V 7 12AX7/ECC83
- V 8 EMM801
- V 9 6V4/EZ80
- V 71 6BL8/ECF80
- V 72 12AX7/ECC83

volume control—dual, 250,000 ohms each section with push-pull switch

fuse—1 ampere slo-blo pilot lamp—#47

# SCHEMATIC DIAGRAM

